

# Modelação Geométrica e Generativa

20181260

Alexandre Carvalho



**U** LISBOA

UNIVERSIDADE  
DE LISBOA

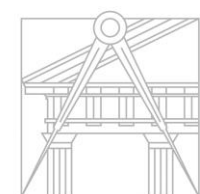

FACULDADE DE ARQUITETURA  
UNIVERSIDADE DE LISBOA

**MGeG**

Mestrado Integrado em Arquitectura  
Ano Lectivo 2022-2023 1º Semestre  
Docente - Nuno Alão 4º Ano

# ÍNDICE

## 1. Exercícios QGIS – Slide 4

- Exercício 1.1 – Slide 5
- Exercício 1.2 – Slide 6

## 2. Exercícios Poliedros – Slide 7

- Exercício 2.1 – Slide 8

## 3. Exercícios Terreno – Slide 10

- Exercício 3.1 – Slide 11
- Exercício 3.2 – slide 13

## 4. Exercícios Conchas – Slide 15

- Exercício 4.1 – Slide 16
- Exercício 4.2 – Slide 19
- Exercício 4.2 – Slide 22
- Exercício 4.3 – Slide 25
- Exercício 4.4 – Slide 25
- Exercício 4.5 – Slide 28
- Exercício 4.6 – Slide 31
- Exercício 4.7 – Slide 34
- Exercício 4.8 – Slide 37
- Exercício 4.9 – Slide 40
- Exercício 4.10 – Slide 43

## 5. Exercícios Corais – Slide 46

- Exercício 5.1 – Slide 47
- Exercício 5.2 – Slide 49
- Exercício 5.3 – Slide 51
- Exercício 5.4 – Slide 53

## 6. Exercício Anêmona – Slide 55

- Exercício 6.1 – Slide 56

## 7. Exercícios Abóbadas – Slide 58

- Exercício 7.1 – Slide 59
- Exercício 7.2 – Slide 62
- Exercício 7.3 – Slide 65
- Exercício 7.4 – Slide 68
- Exercício 7.5 – Slide 71
- Exercício 7.6 – Slide 74
- Exercício 7.7 – Slide 77
- Exercício 7.8 – Slide 80
- Exercício 7.9 – Slide 83

## 8. Exercícios Grasshopper – Slide 86

- Exercício 8.1 – Slide 87
- Exercício 8.2 – Slide 89



# 1- Exercícios QGIS

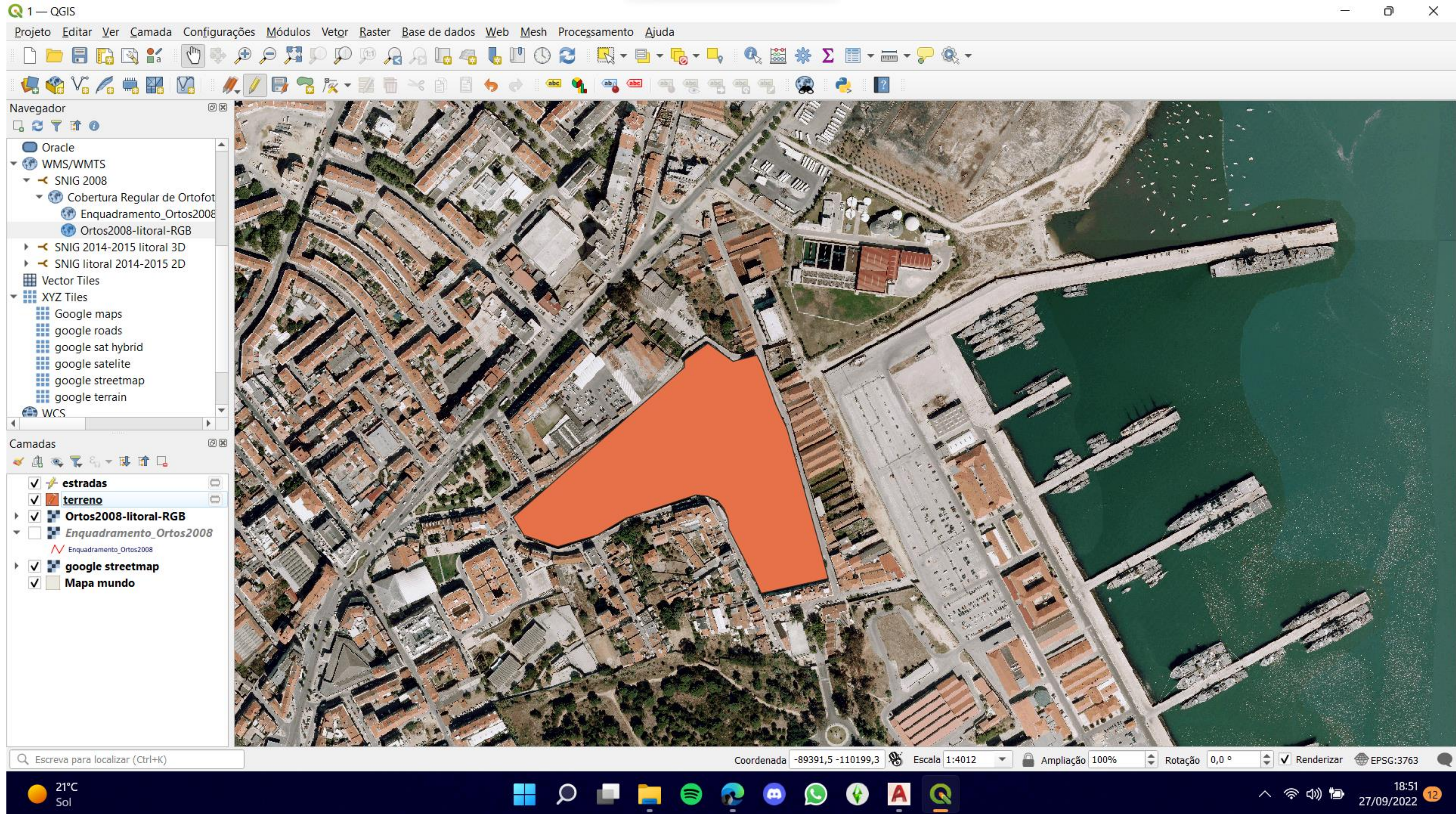

# Exerc. 1.1 – QGIS

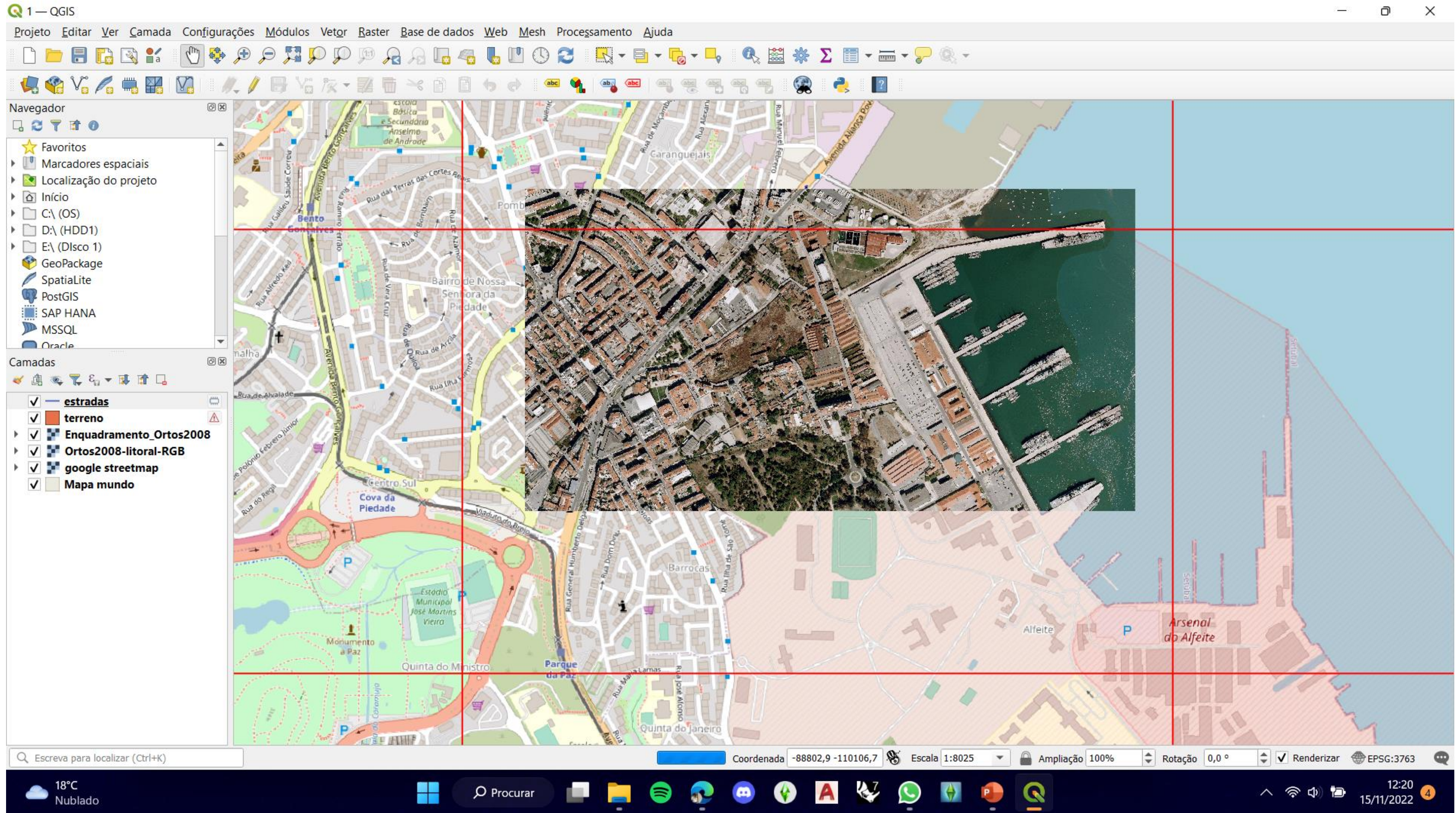

# Exerc. 1.2 - QGIS



# 2- Exercícios Poliedros

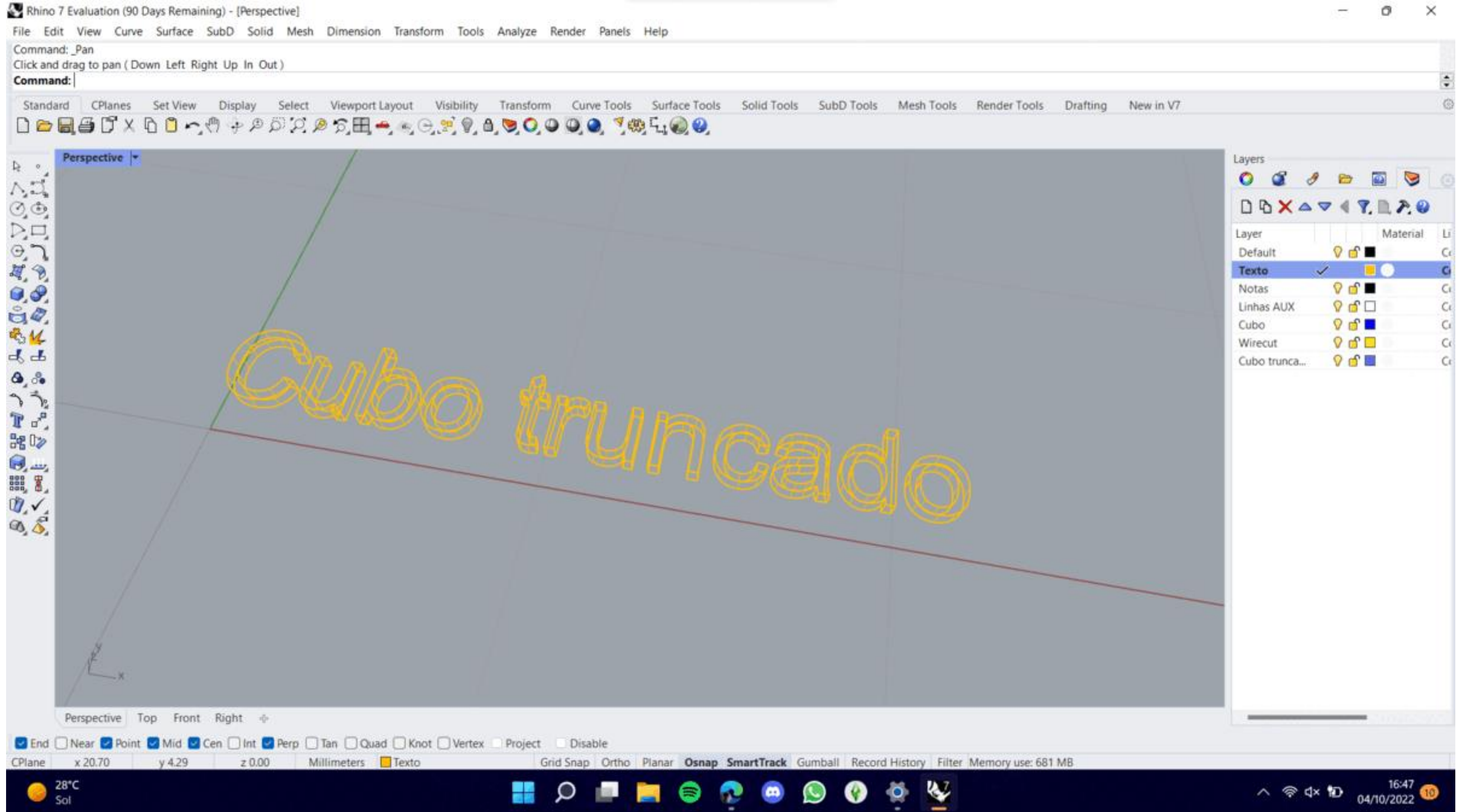

# Exerc. 2.1 - Poliedros



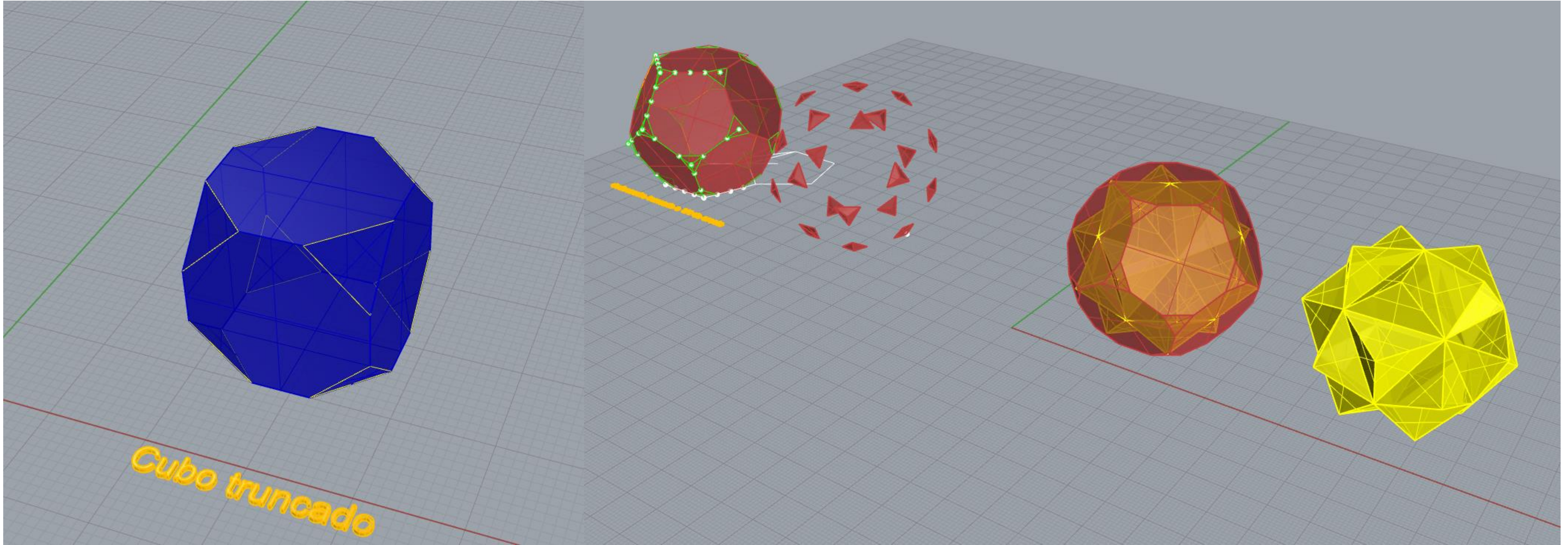

# Exerc. 2.1 - Poliedros



# 3- Exercícios Terreno

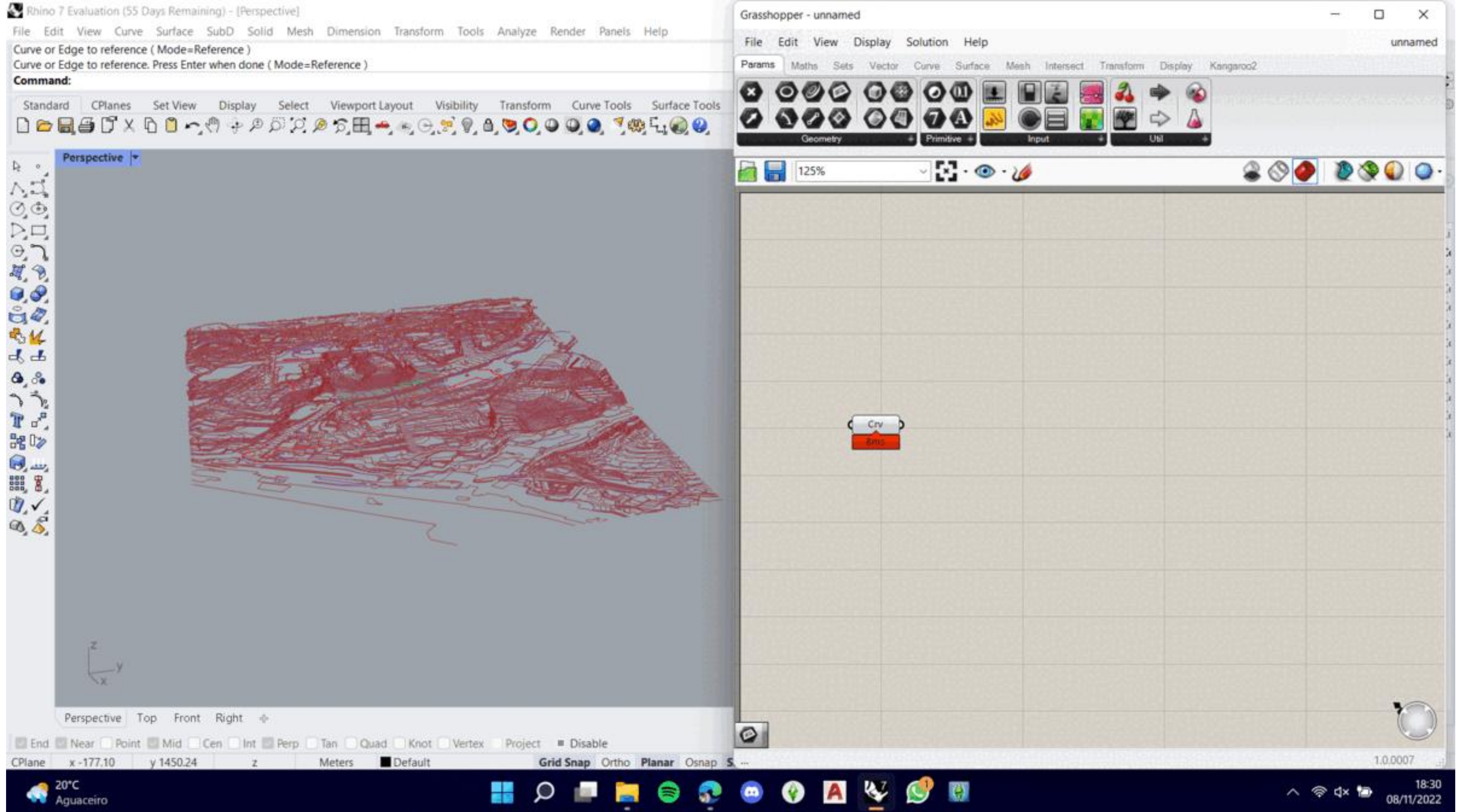

# Exerc. 3.1 - Terreno

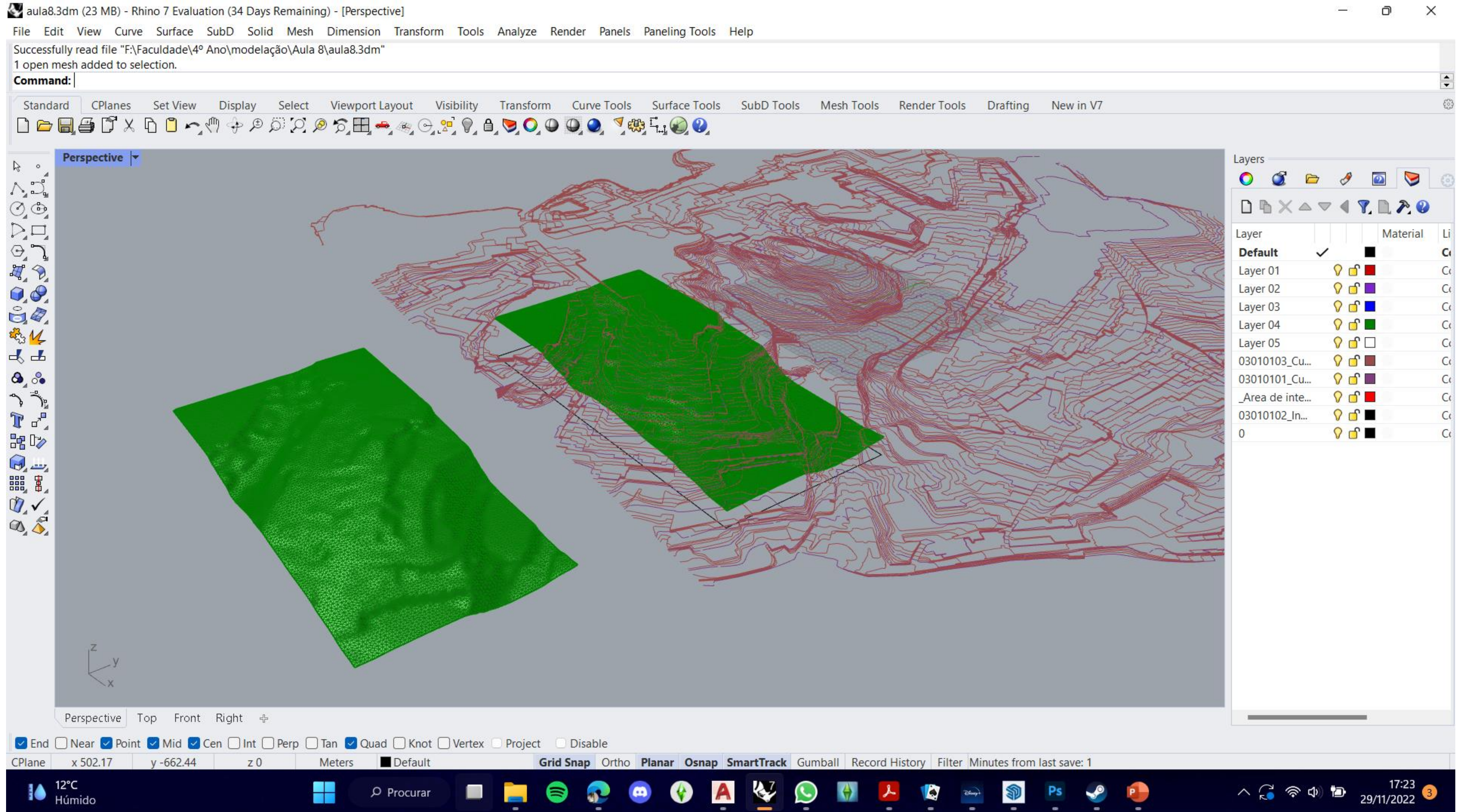

# Exerc. 3.1 - Terreno

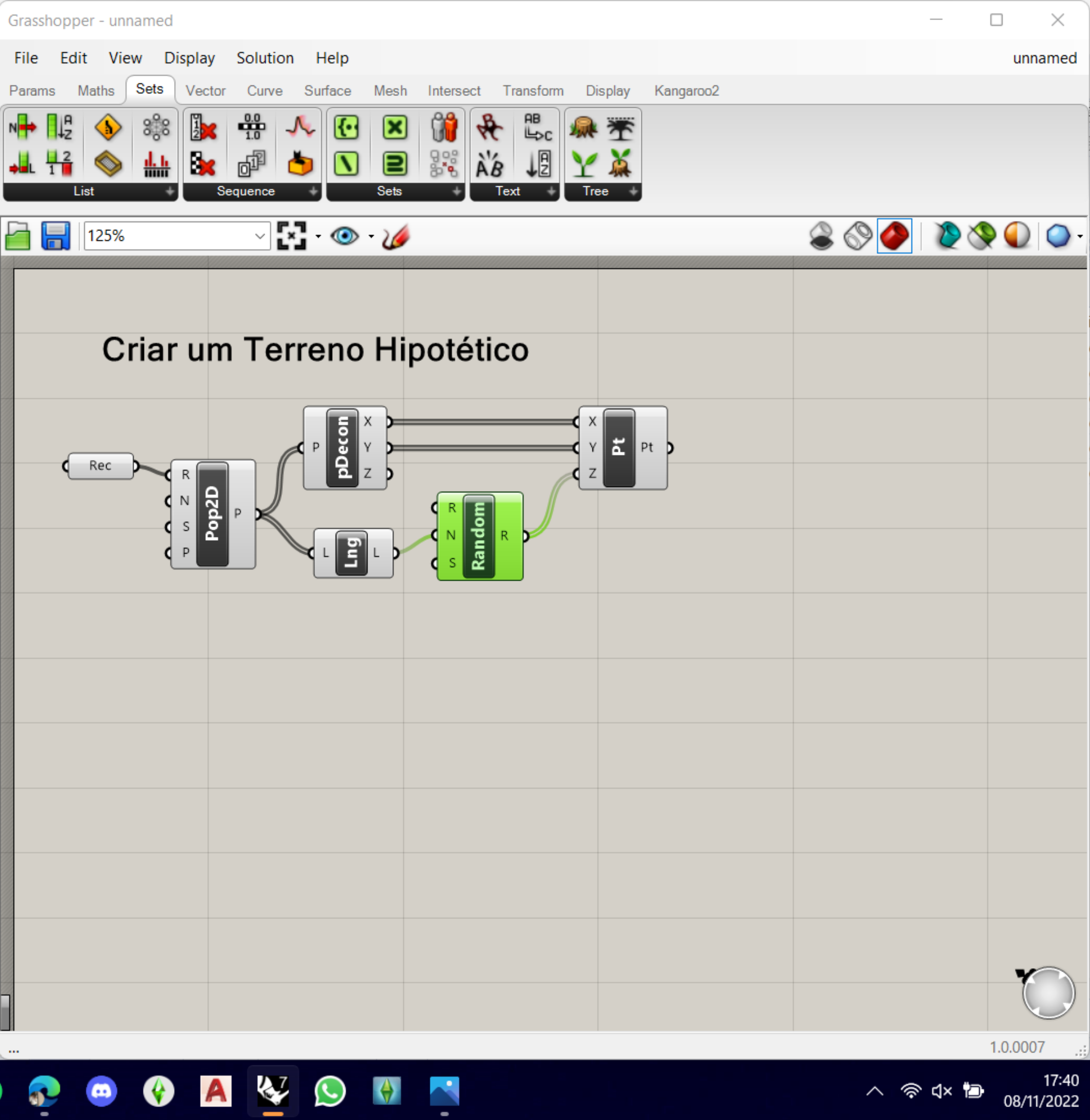
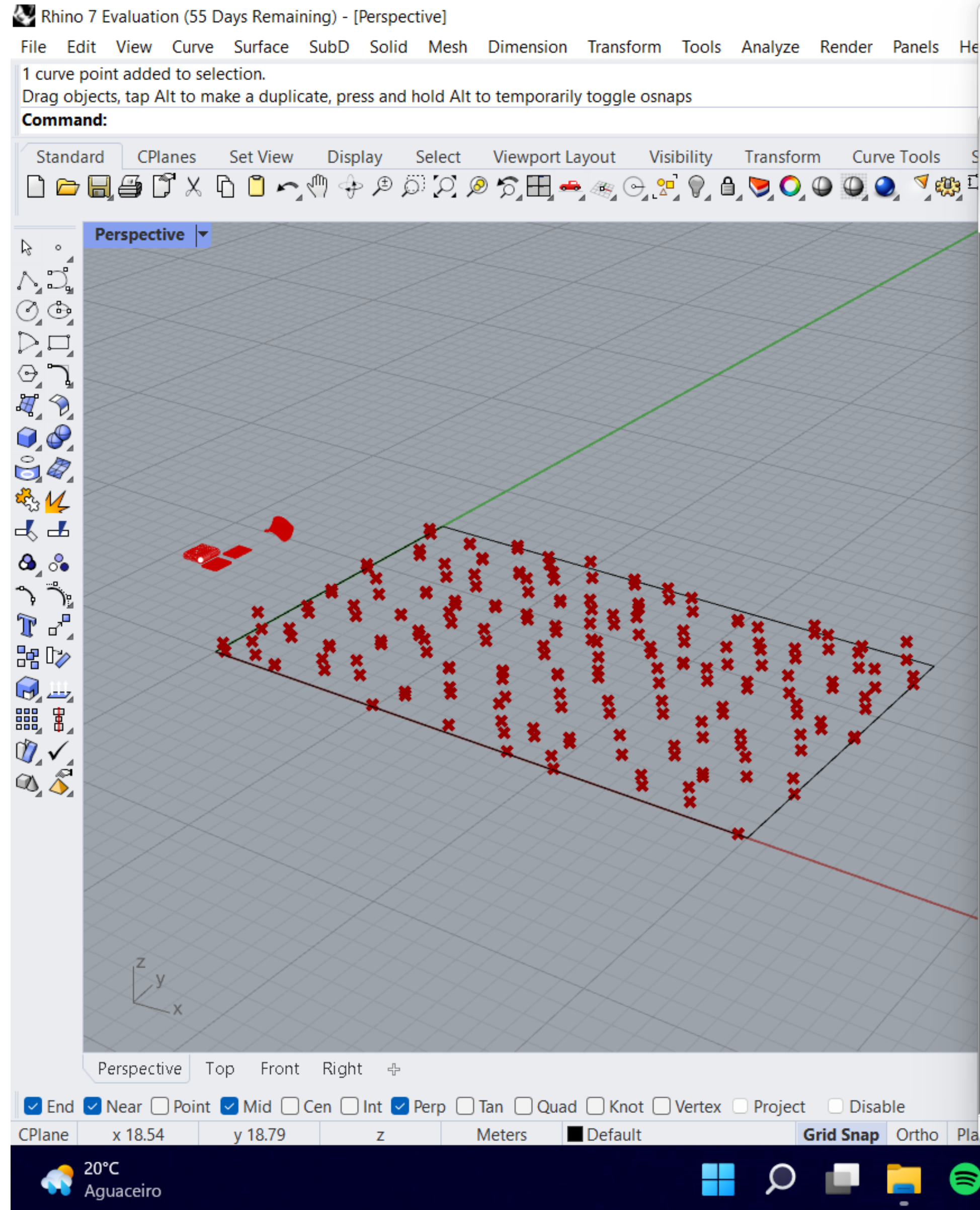

# Exerc. 3.2 – Terreno hipotético

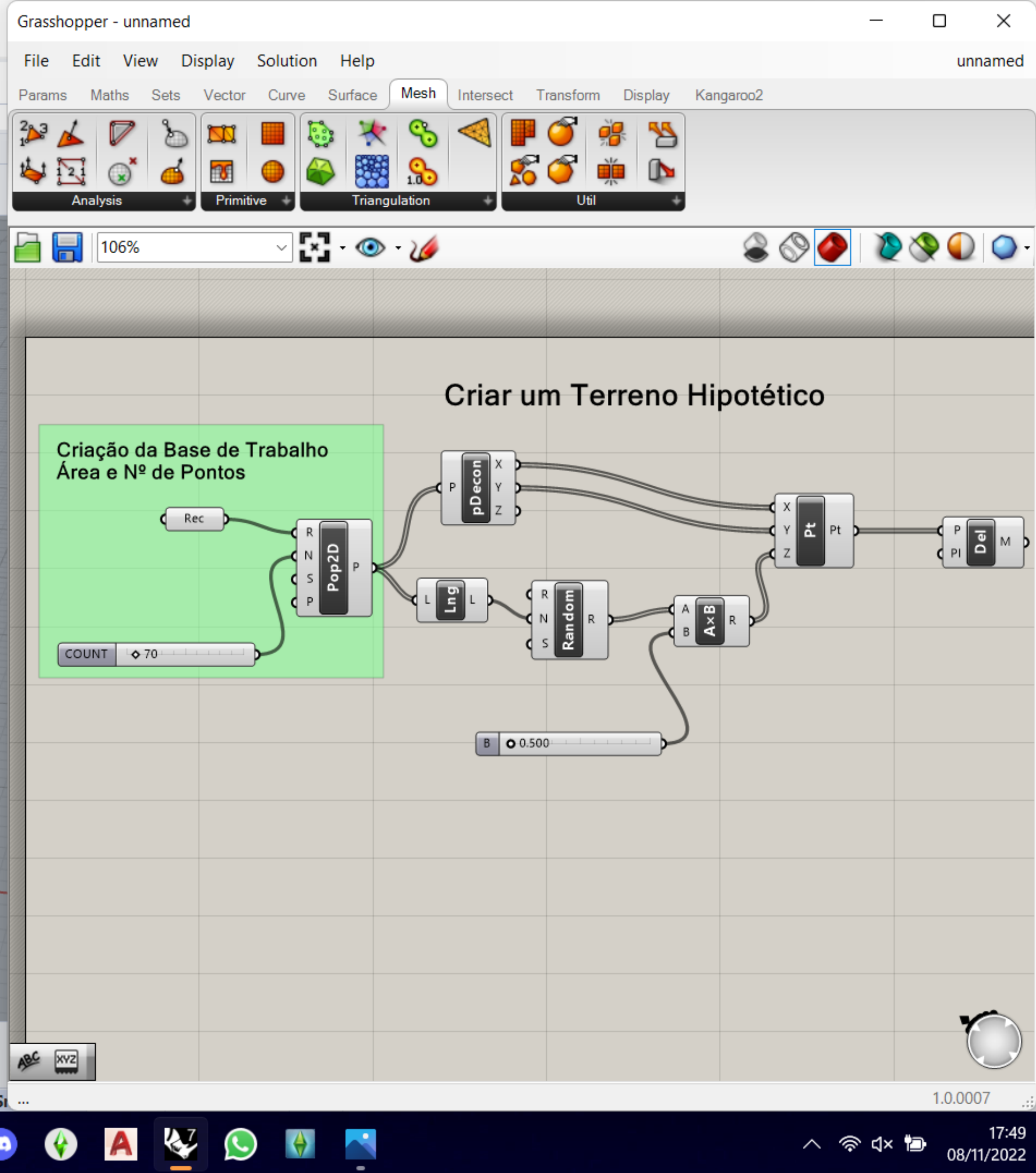
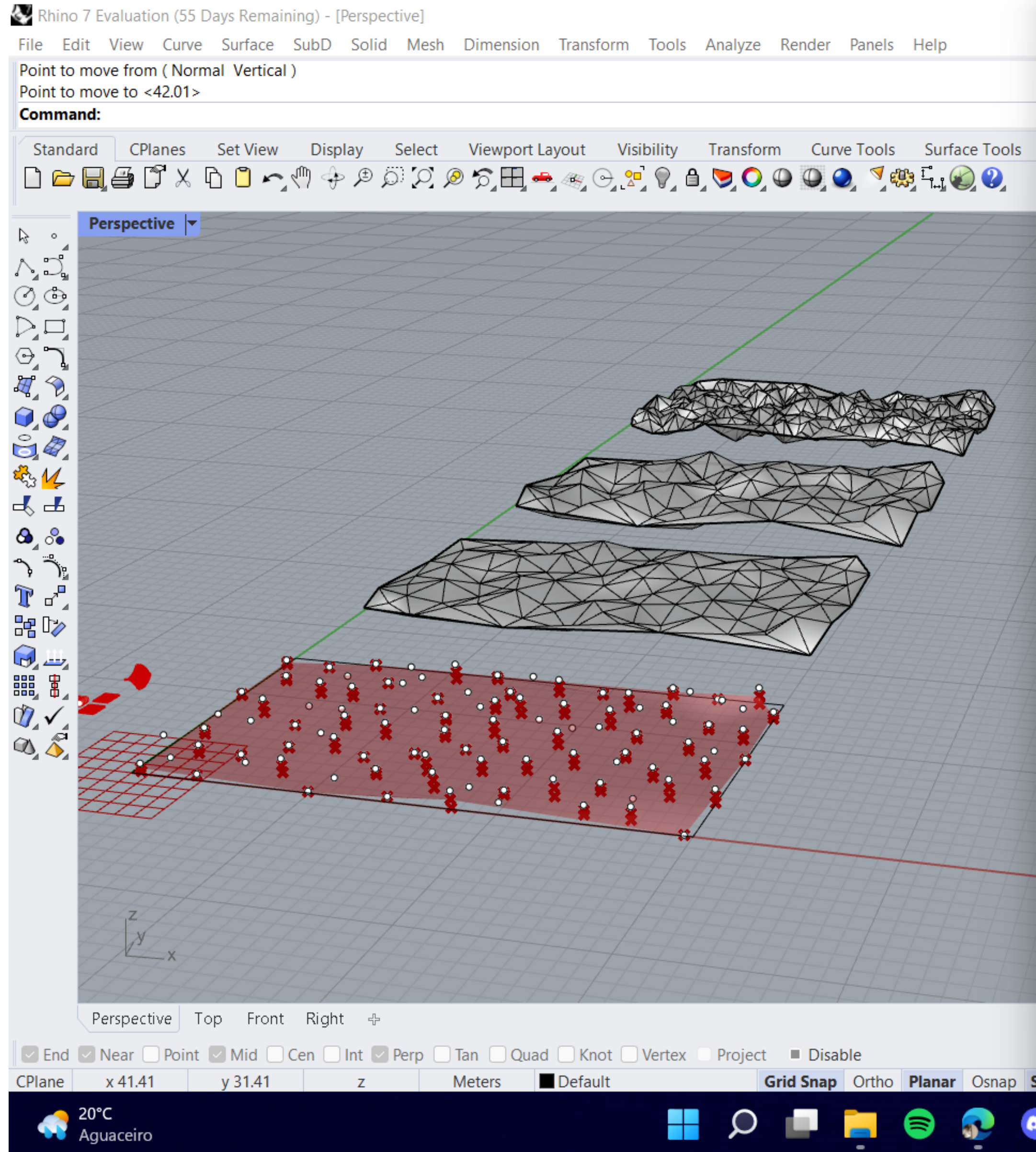

# Exerc. 3.2 – Terreno hipotético



# 4- Exercícios Conchas



Exerc. 4.1 - Spirula



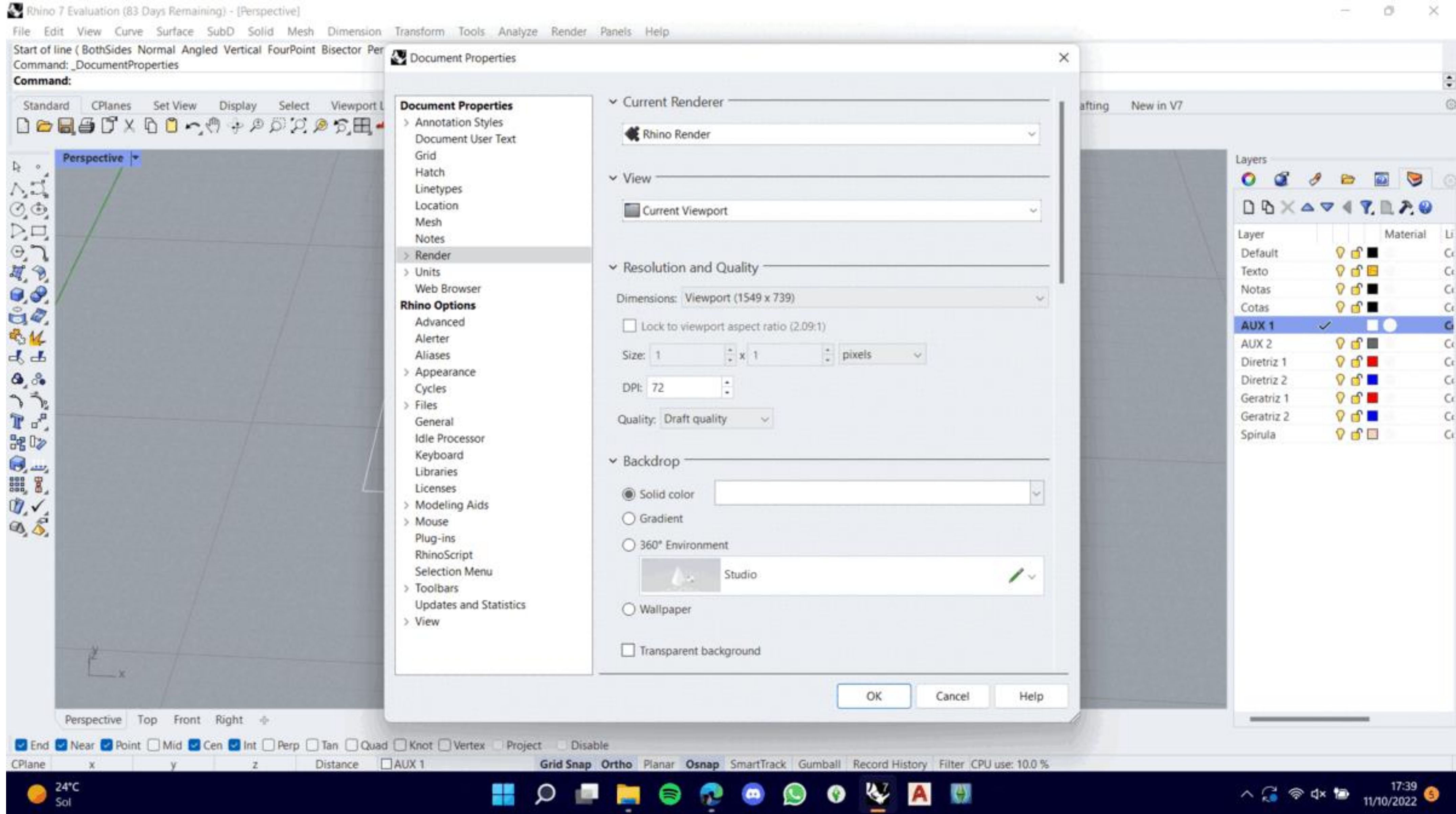

# Exerc. 4.1 - Spirula

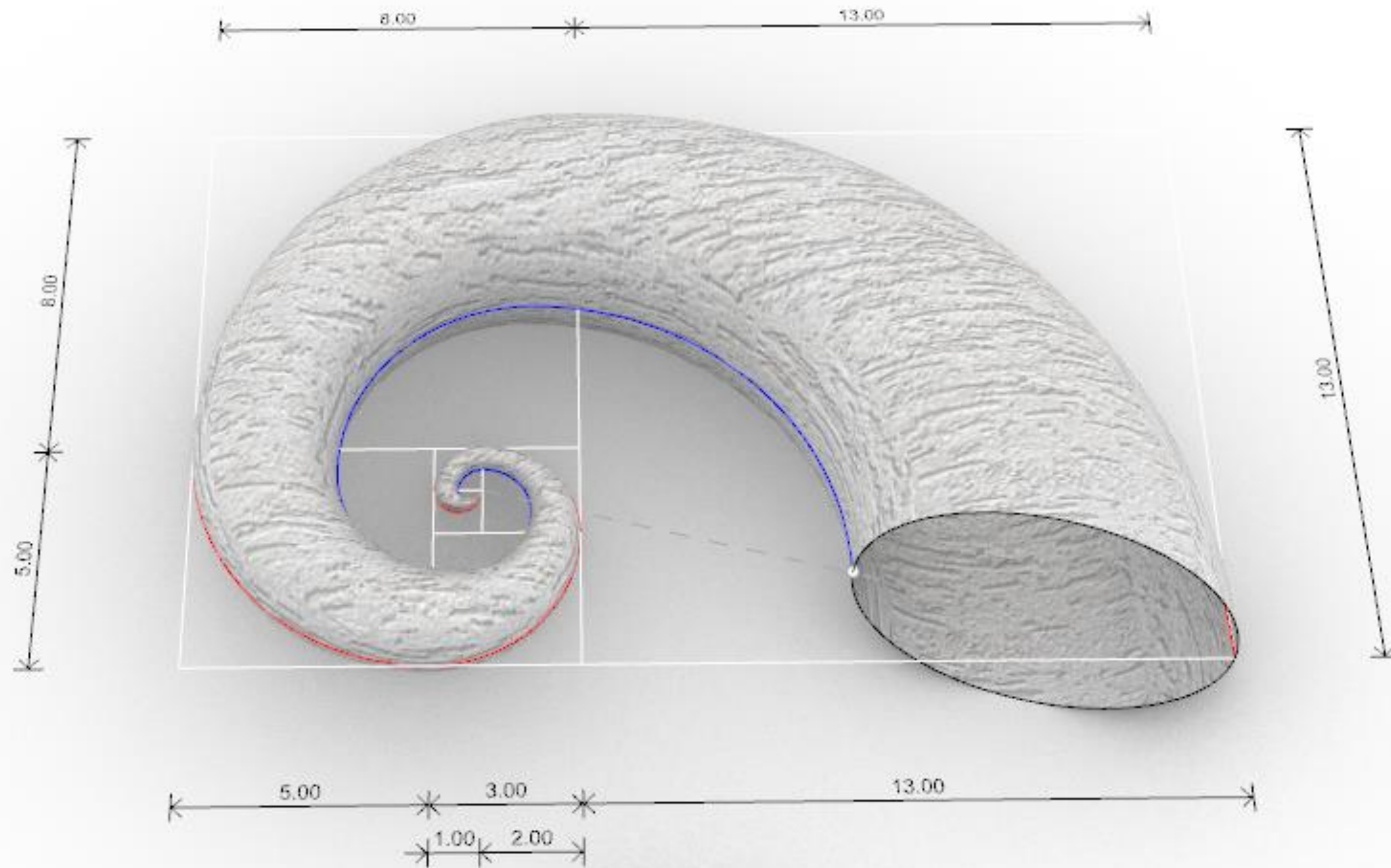

Spirula

Exerc. 4.1 - Spirula



Exerc. 4.2 - Planorbis

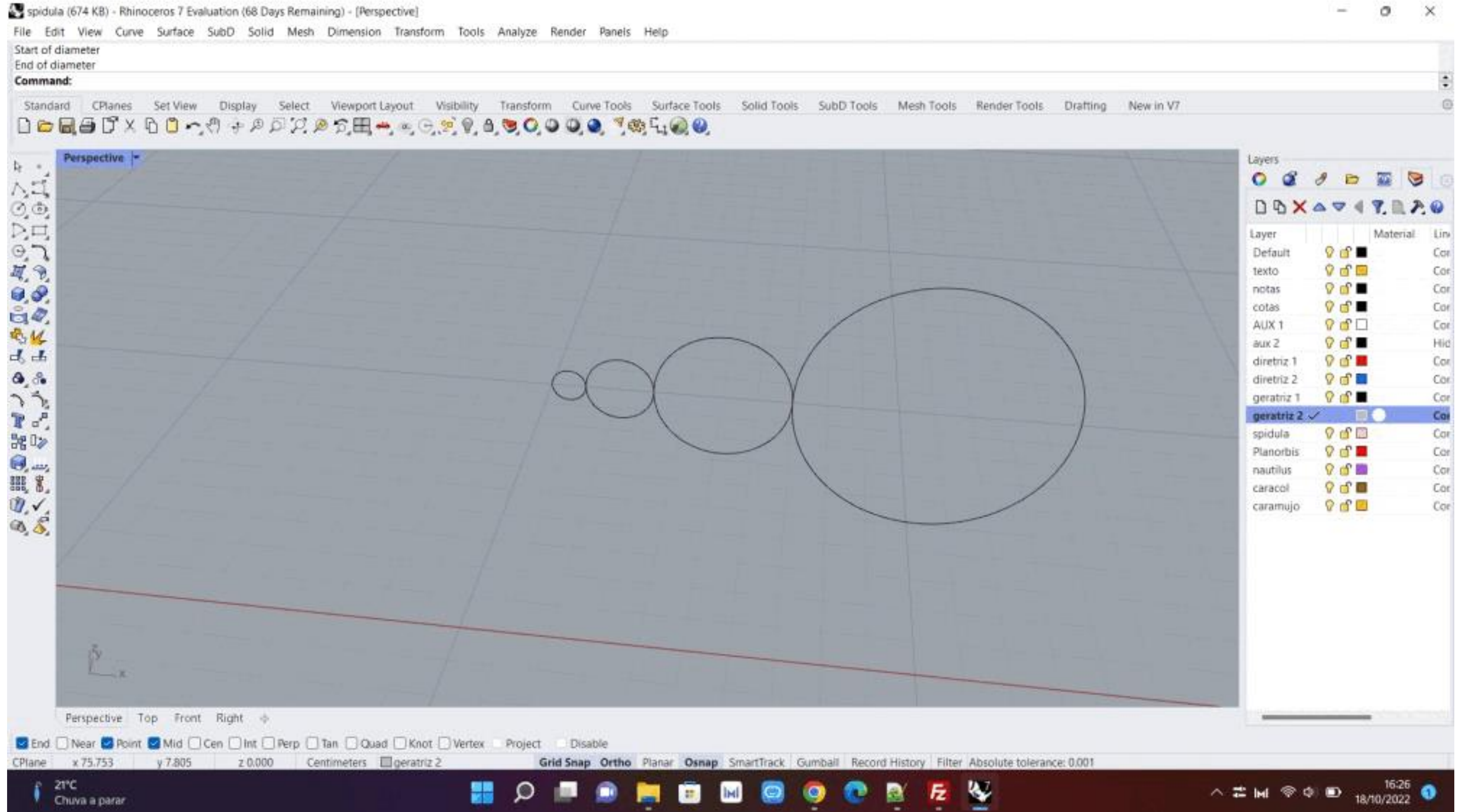

# Exerc. 4.2 - Planorbis

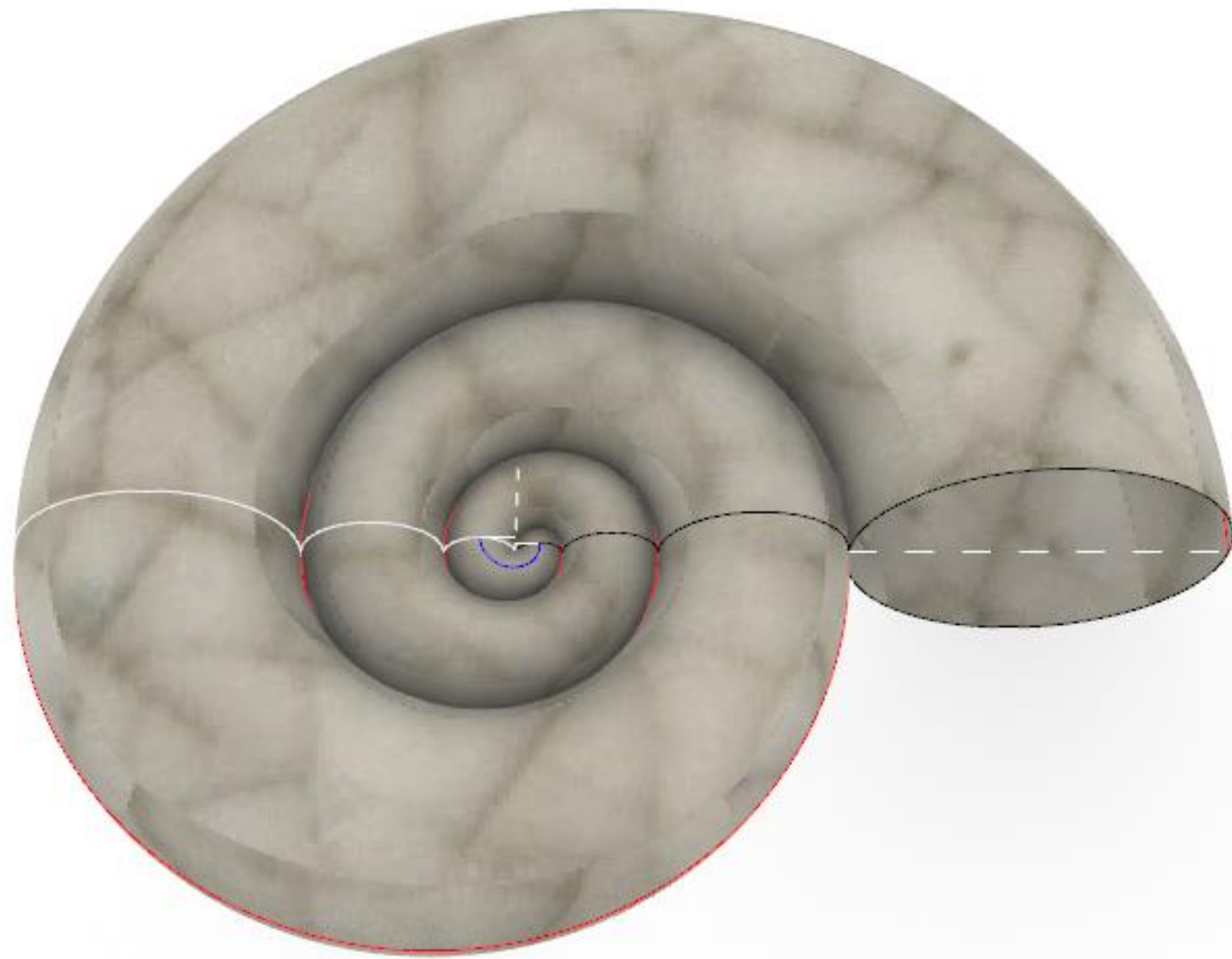

## **Ex 2.2 - Planorbis**

Exerc. 4.2 - Planorbis



©Creative Endeav  
- Steven Oscherwi

## Exerc. 4.3 – Nautilus

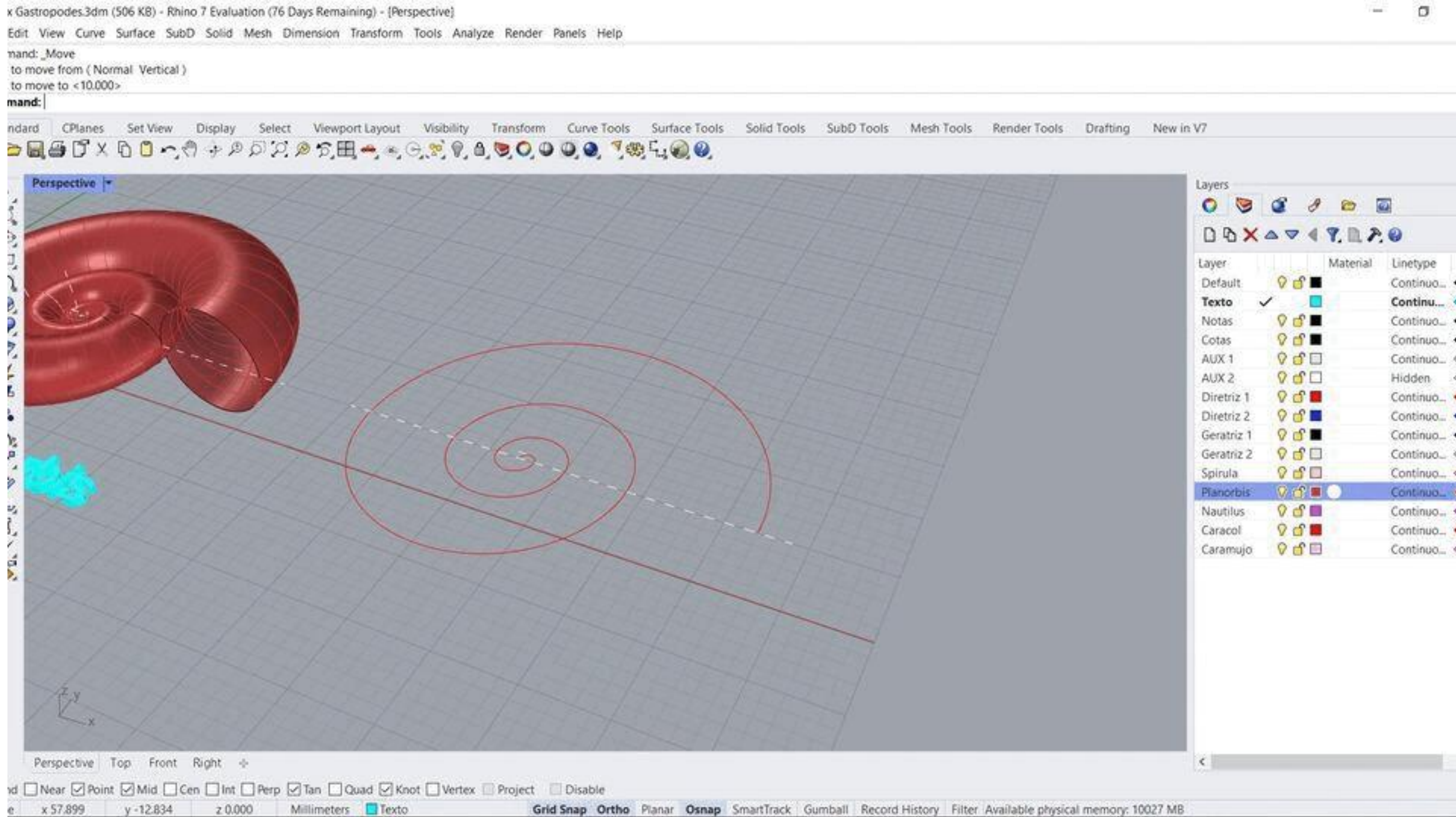

# Exerc. 4.3 – Nautilus

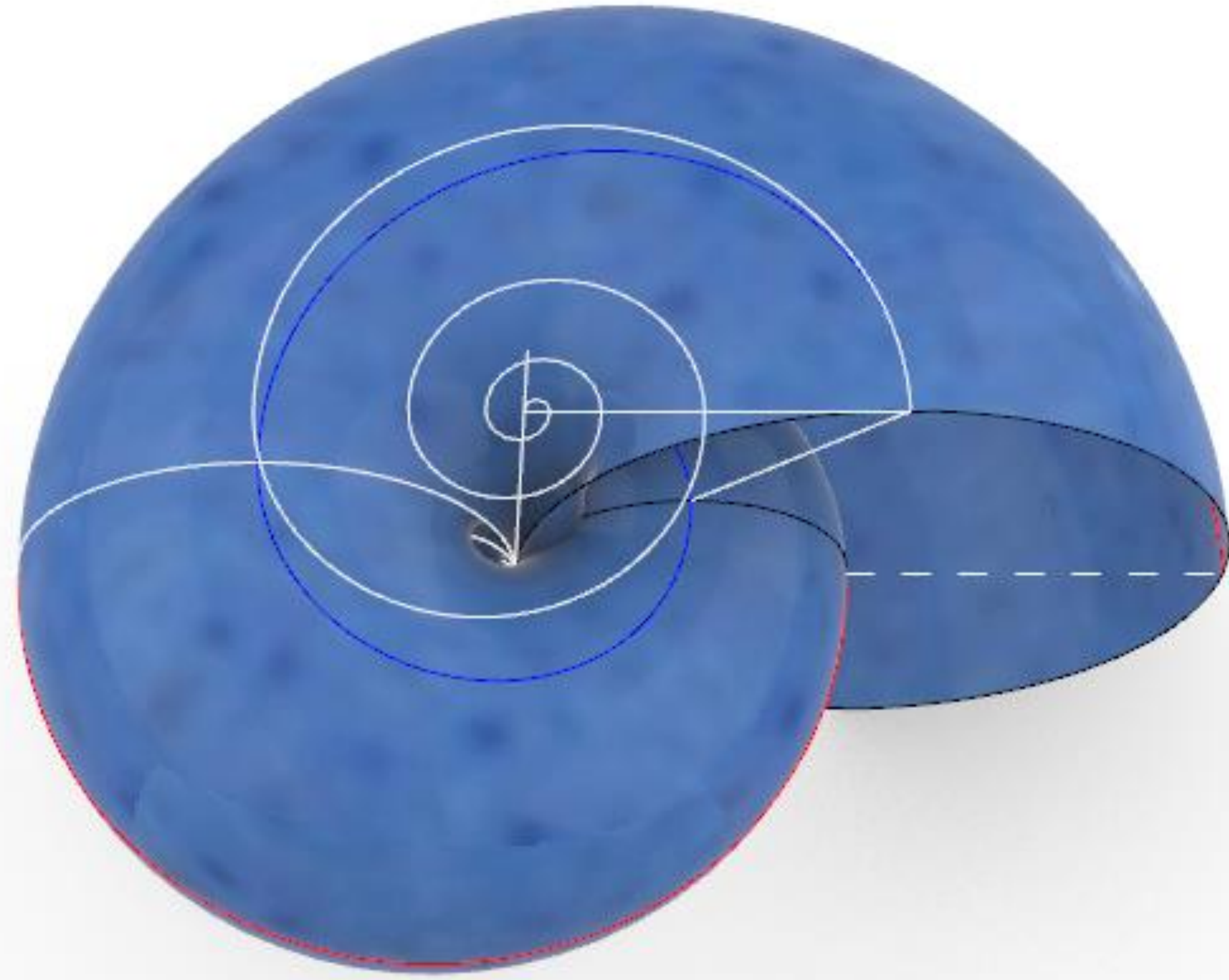

**Ex 2.3 - Nautilus**

Exerc. 4.3 – Nautilus





Exerc. 4.4 – Caracol

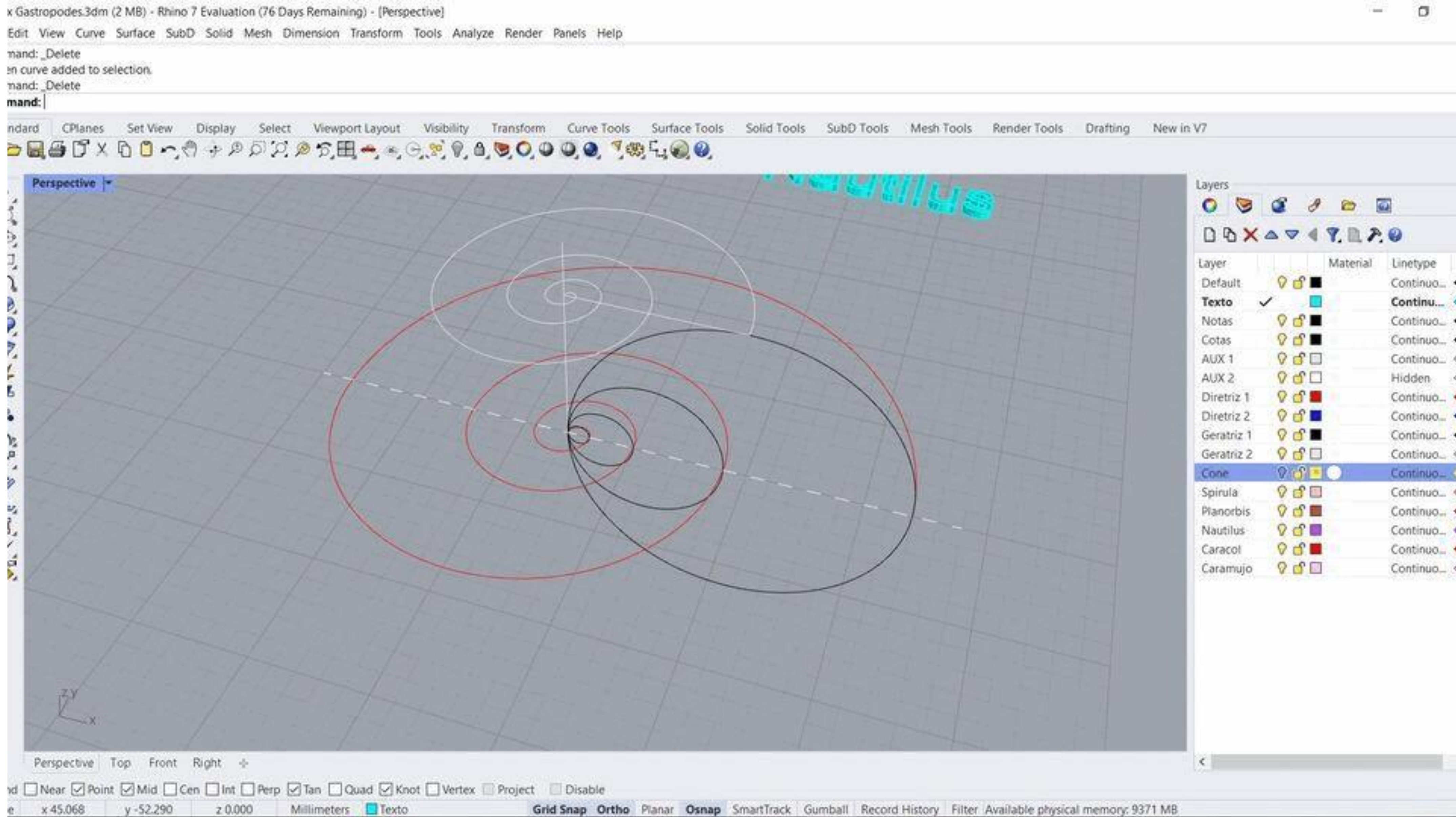

# Exerc. 4.4 – Caracol

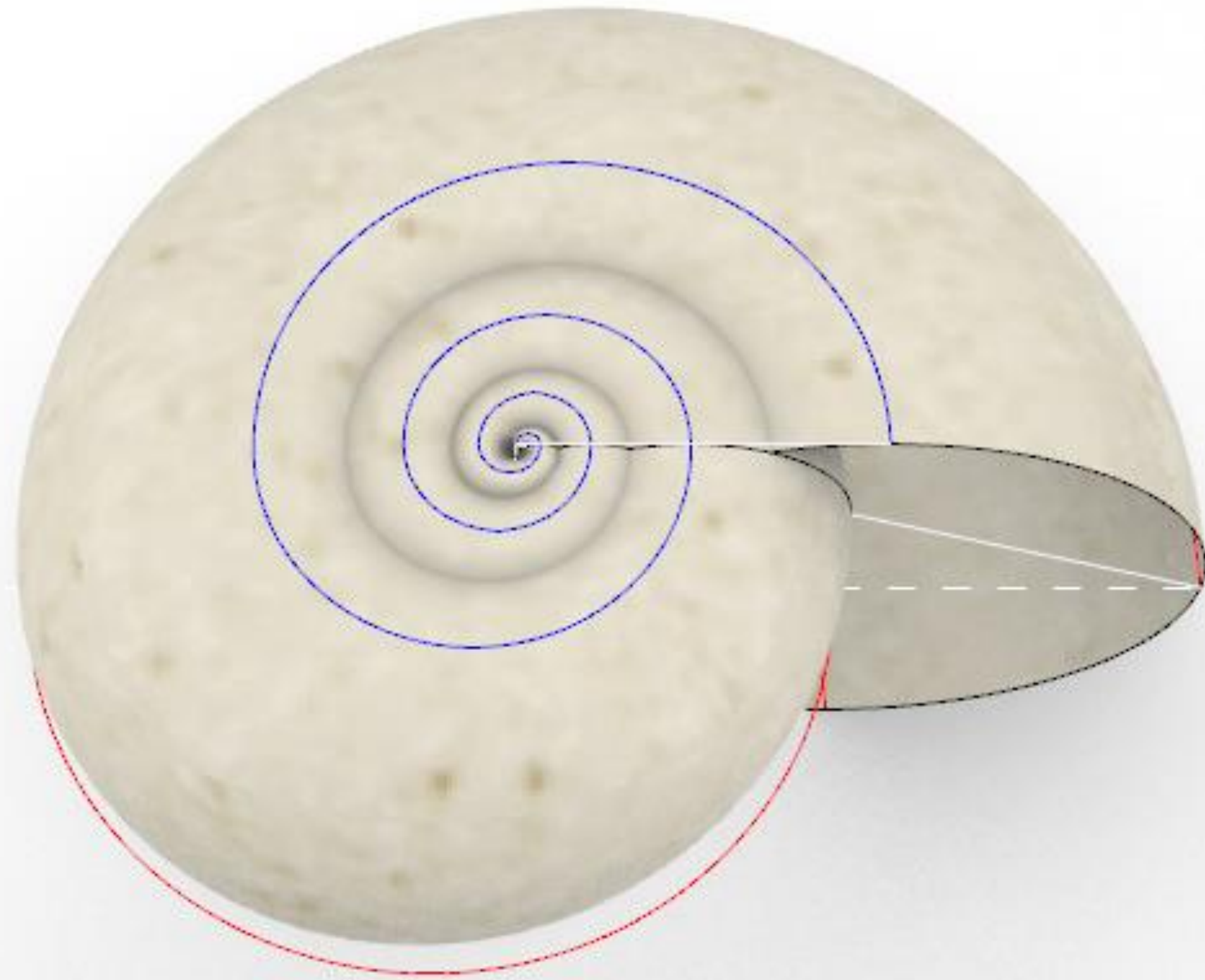

**Ex 2.4 - Caracol**

Exerc. 4.4 – Caracol



Exerc. 4.5 – Caramujo

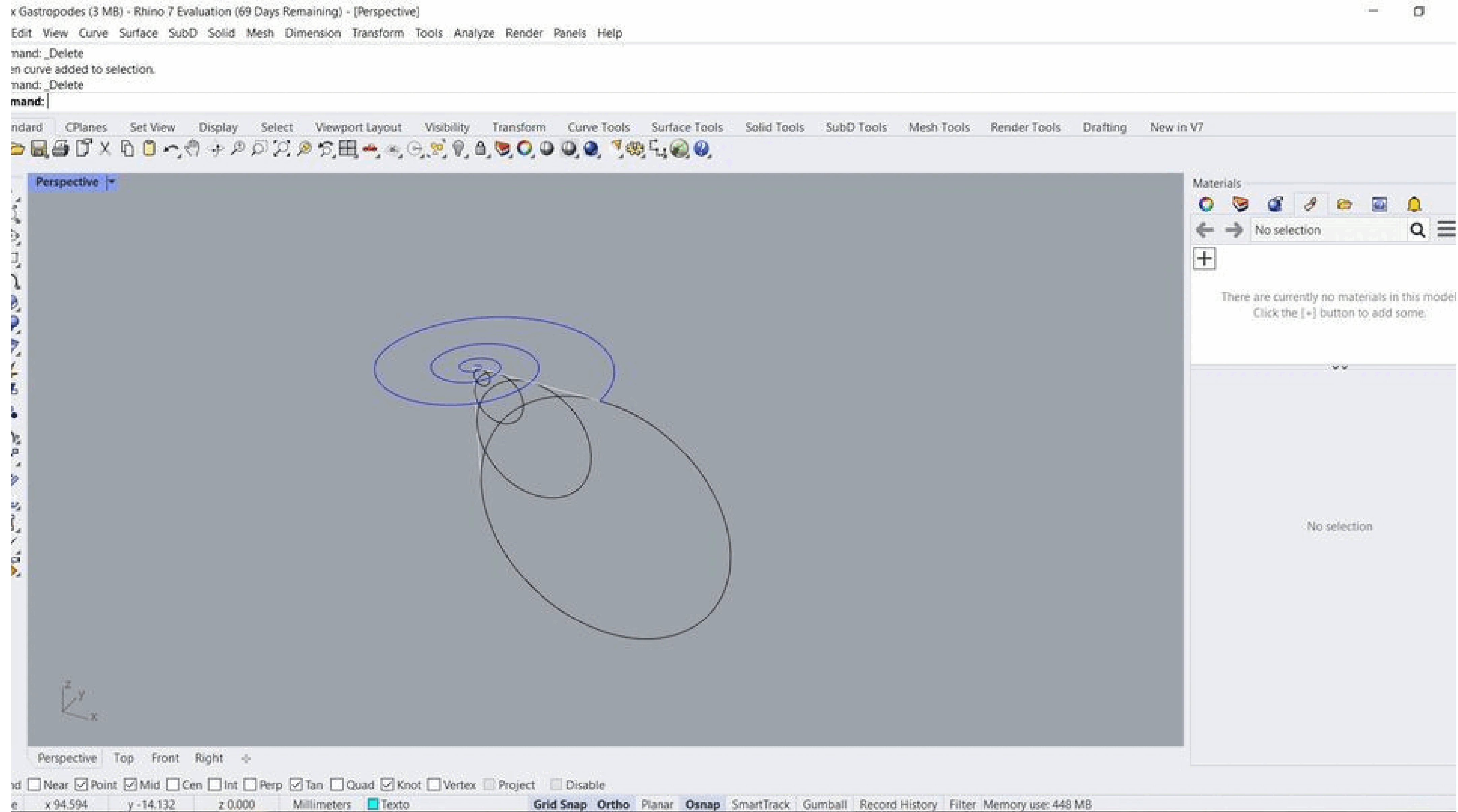

# Exerc. 3.5 – Caramujo

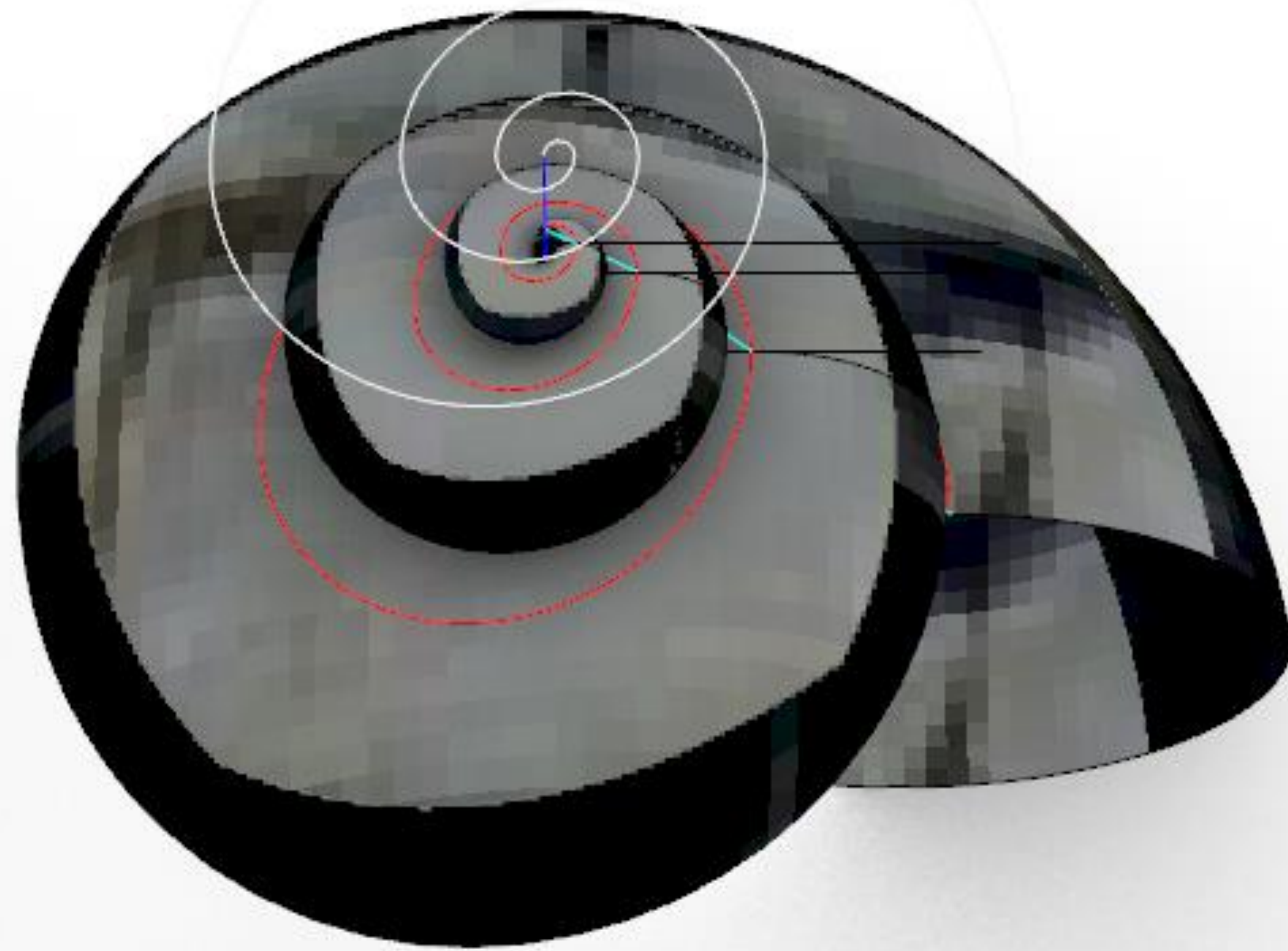

**Ex 2.5 - Caramujo**

Exerc. 4.5 – Caramujo



Exerc. 4.6 – Mexilhão

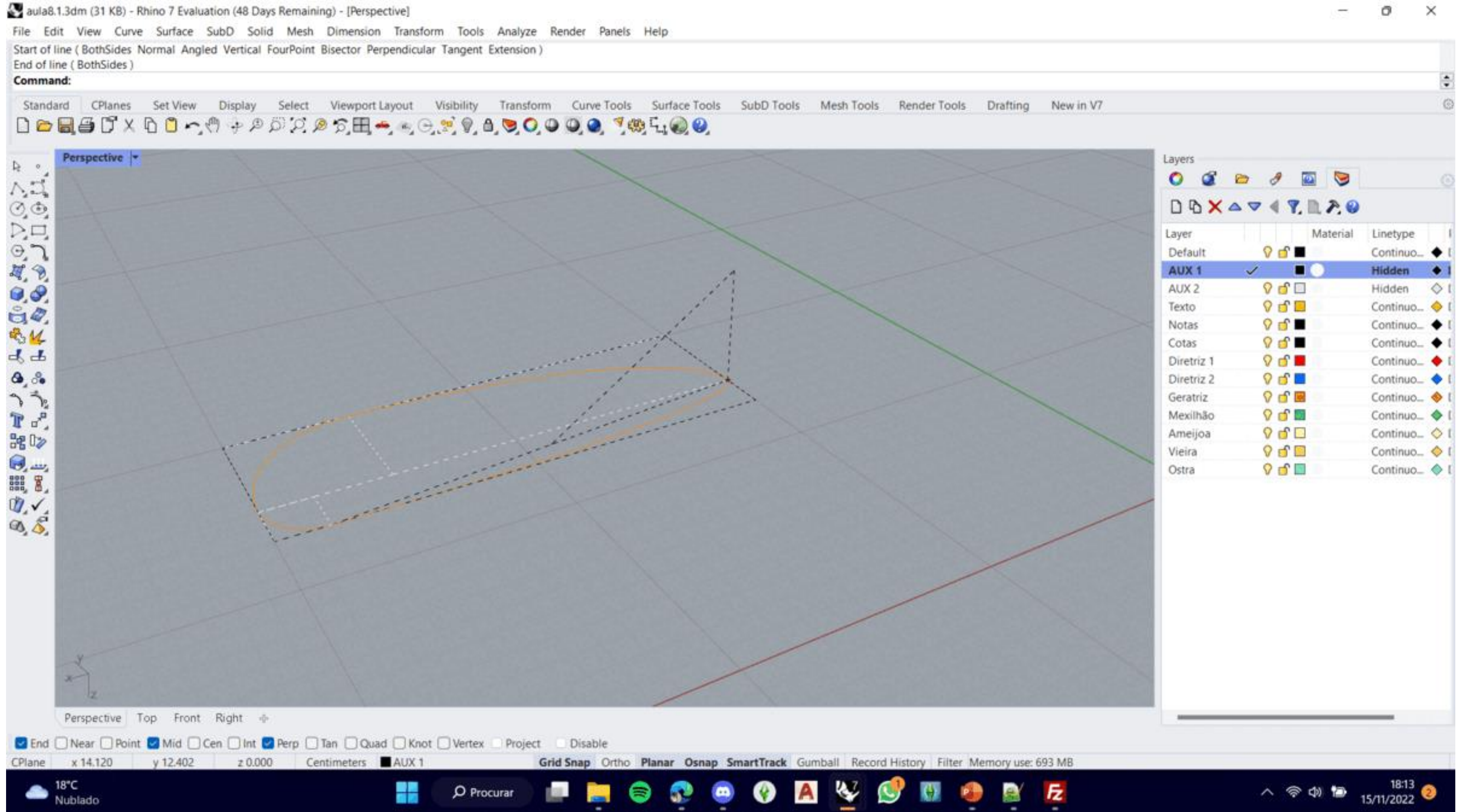

# Exerc. 4.6 – Mexilhão



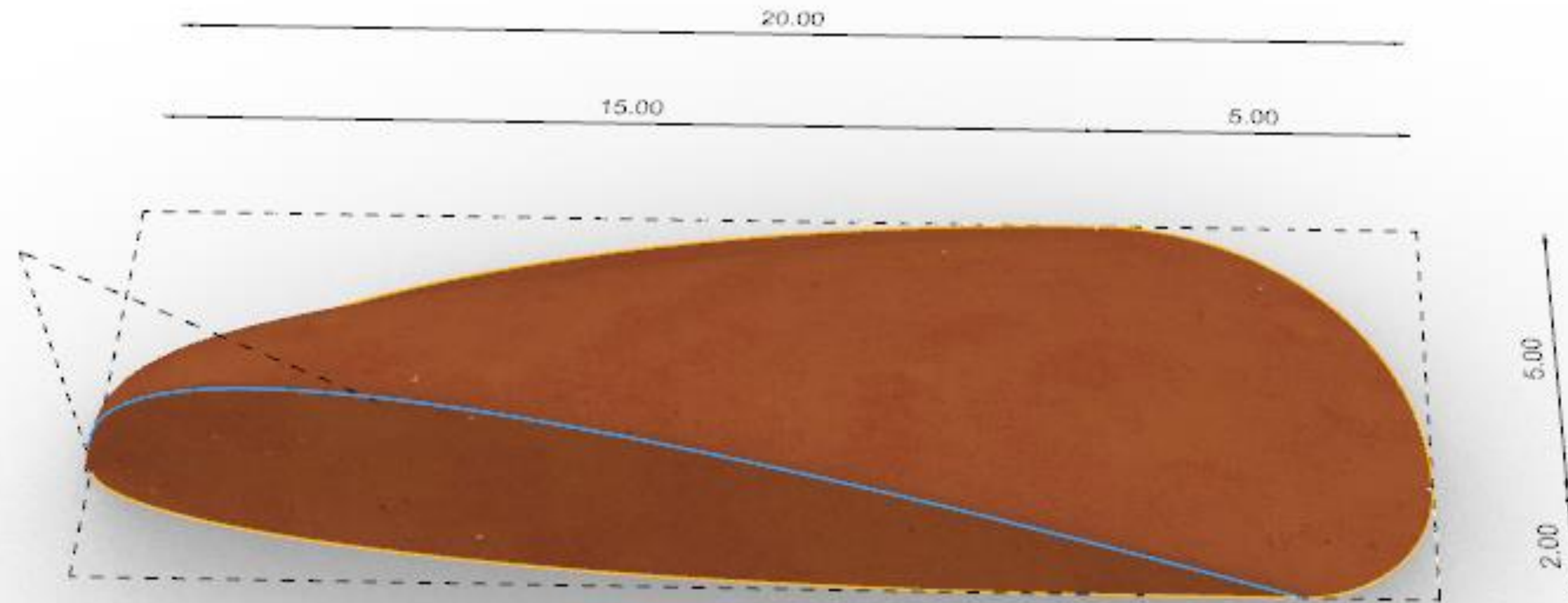

**Exe. 5.1 - Conchas bivalves  
Mexilhão**

Exerc. 4.6 – Mexilhão



Exerc. 4.7 – Amejioa

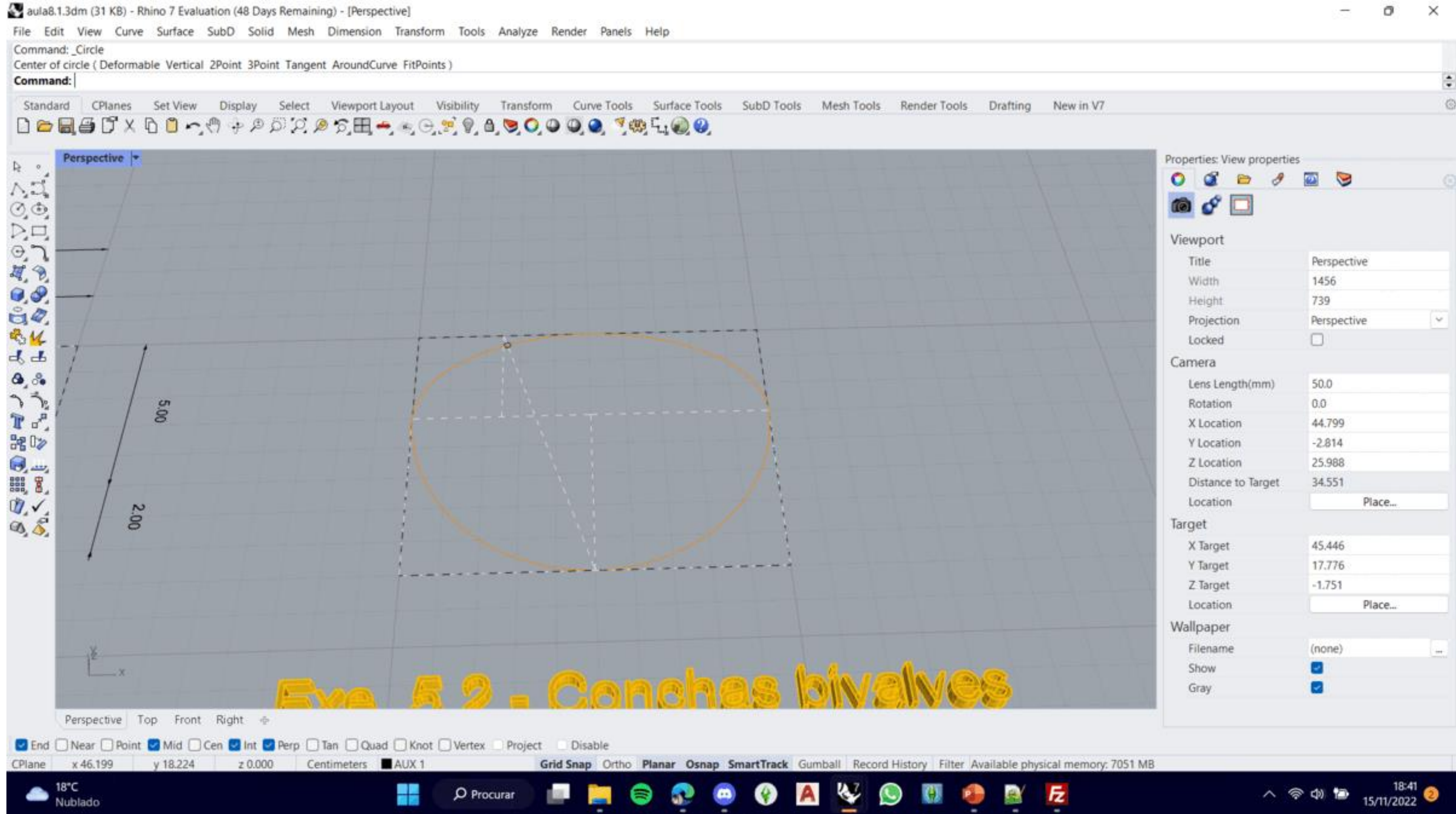

# Exerc. 4.7 – Ameijoas

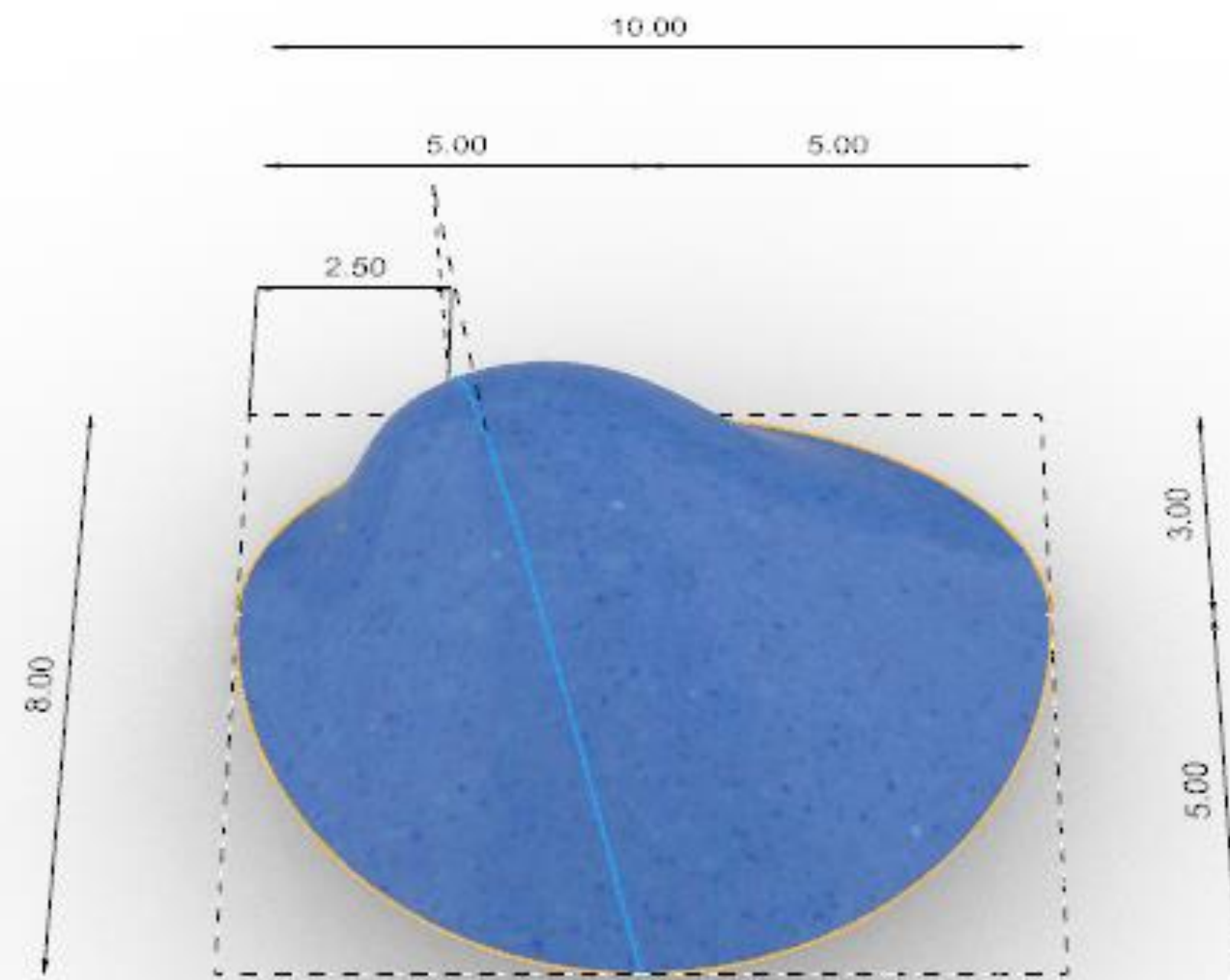

**Exe. 5.2 - Conchas bivalves  
Ameijoa**

Exerc. 4.7 – Ameijoa



Exerc. 4.8 – Vieira

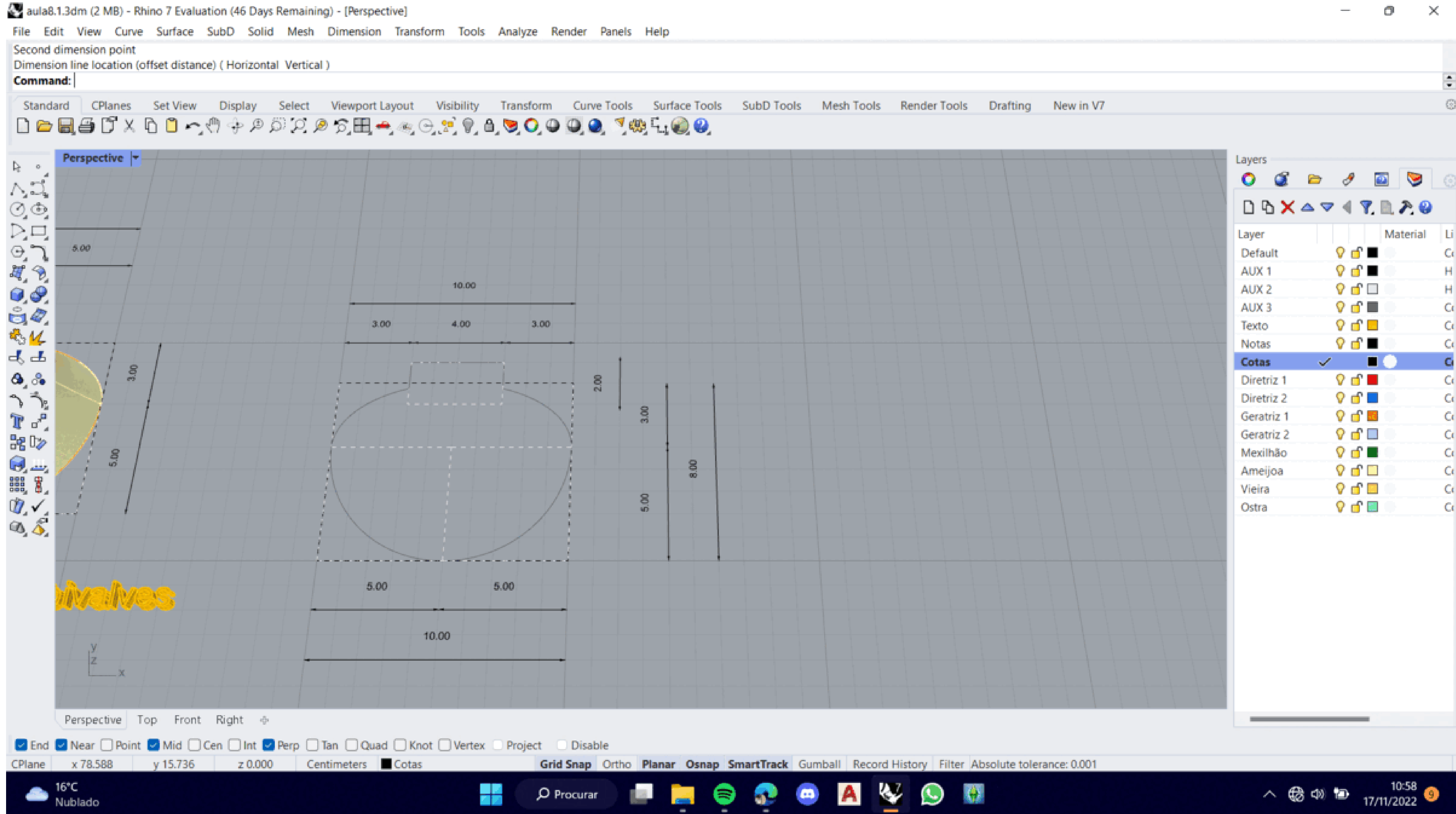

# Exerc. 4.8 – Vieira

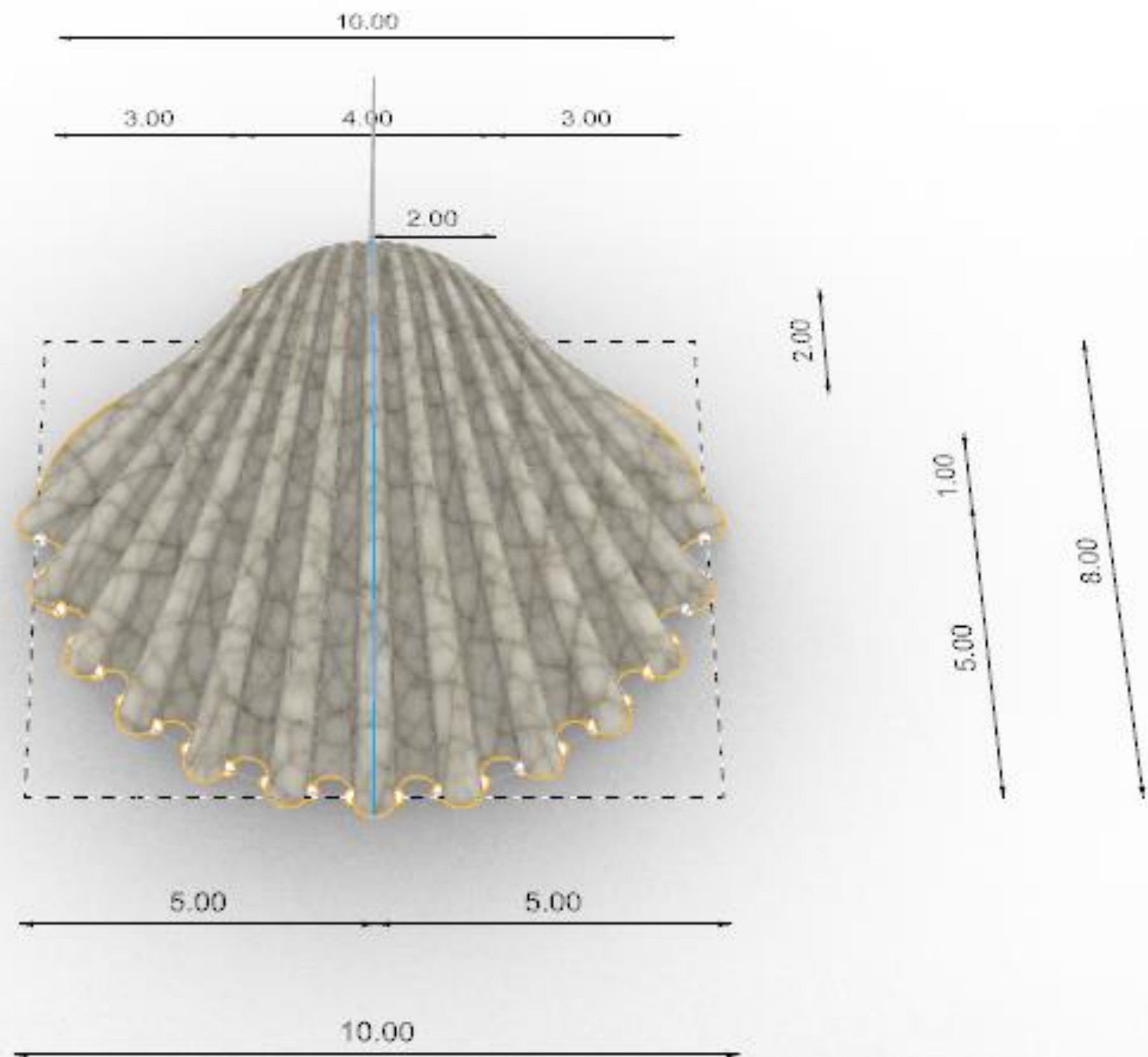

**Exe. 5.3 - Conchas bivalves  
Vieira**

Exerc. 4.8 – Vieira



Exerc. 4.9 – Ostra



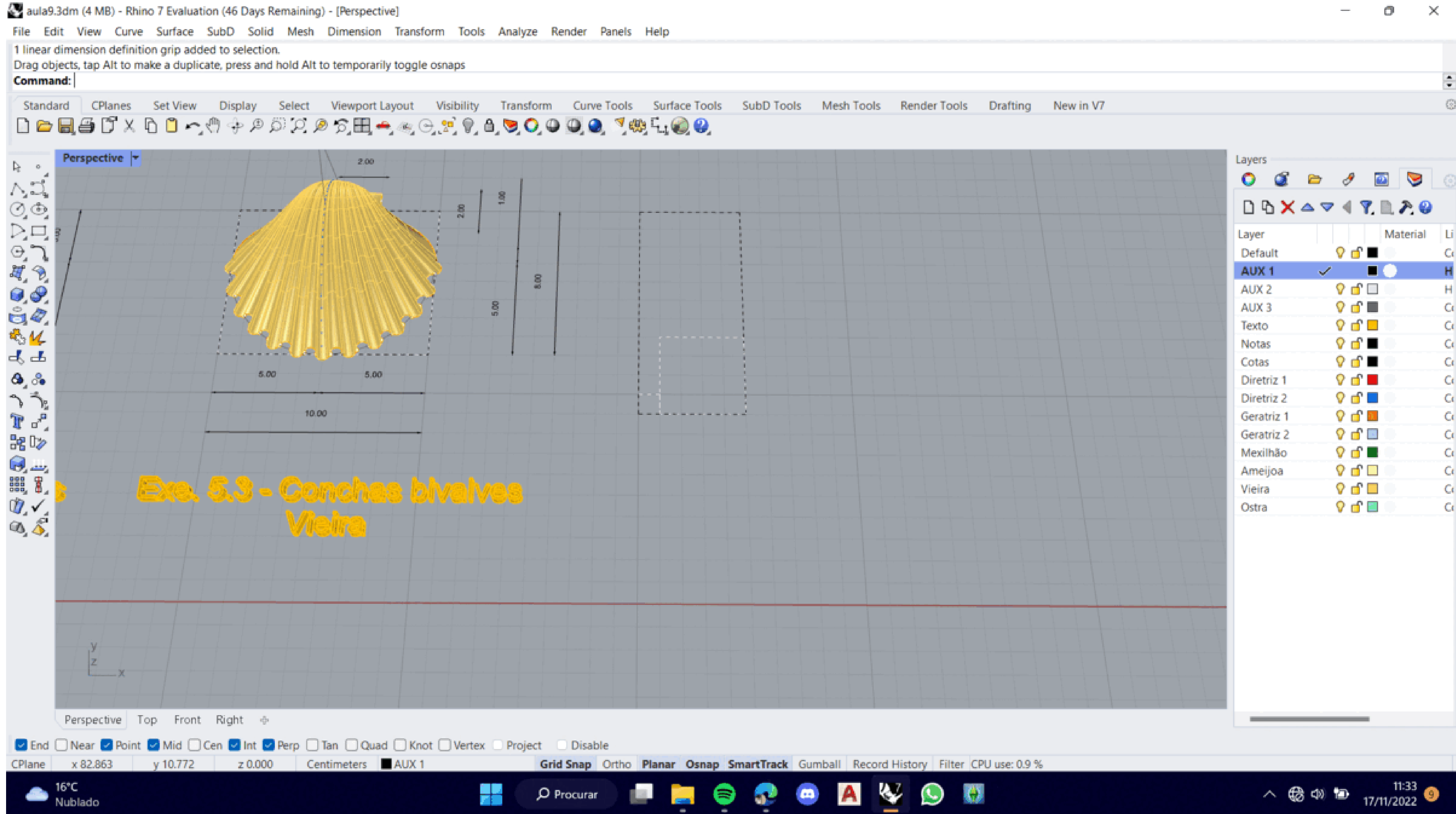

# Exerc. 4.9 – Ostra

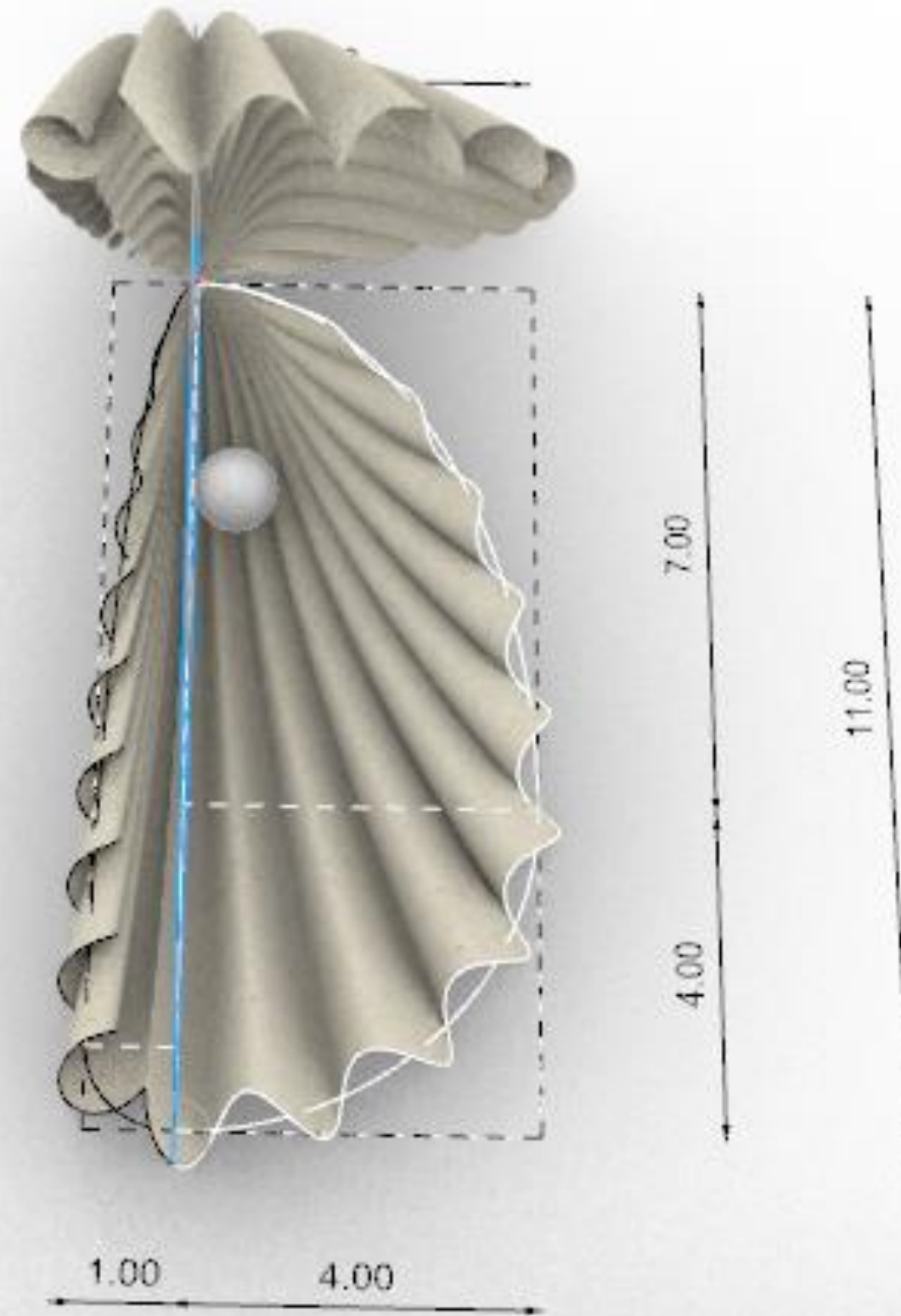

**Exe. 5.3 - Conchas bivalves**  
**Ostra**

Exerc. 4.9 – Ostra



Exerc. 4.10 – Caramujo Grasshopper

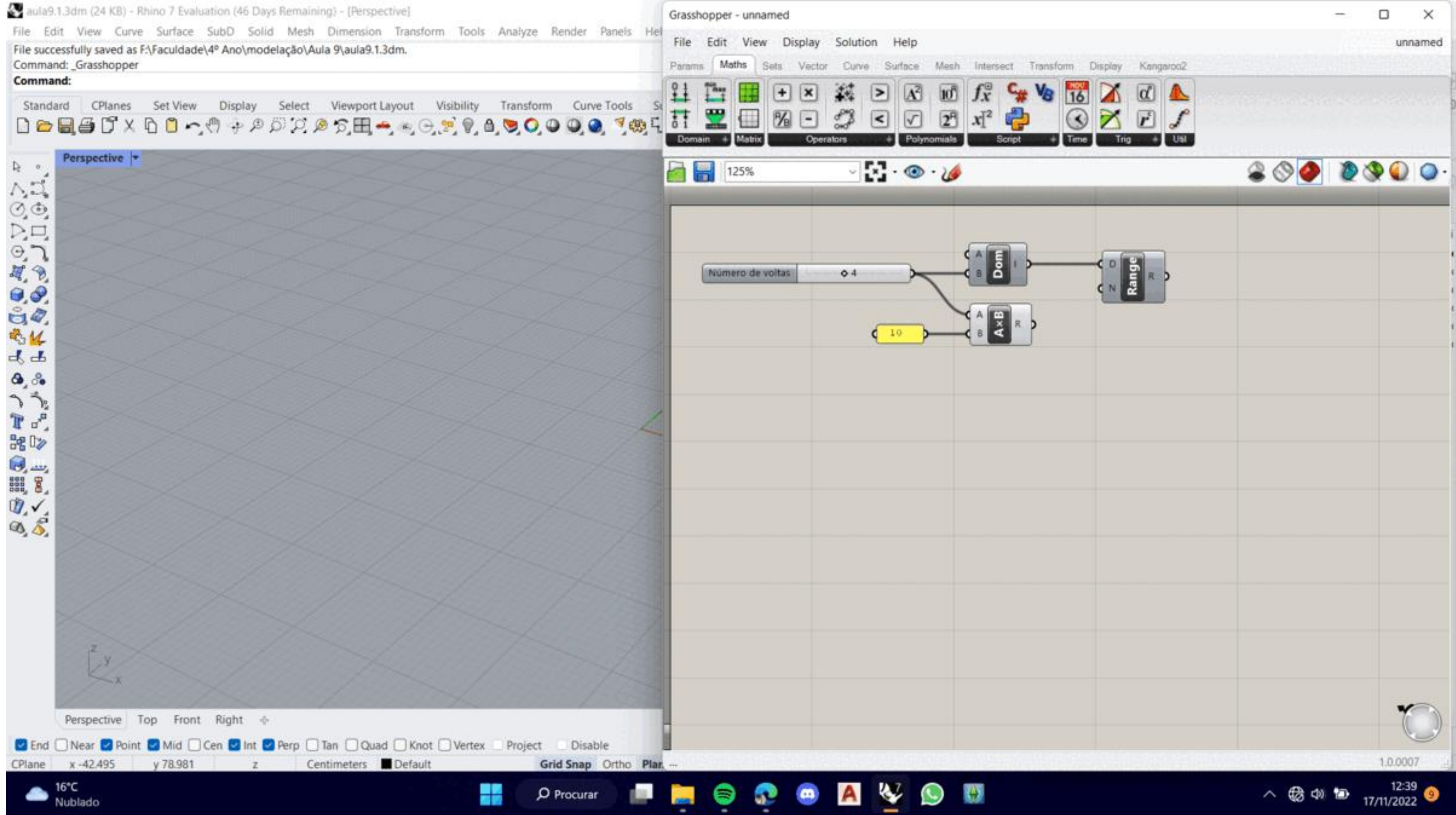

# Exerc. 4.10 – Caramujo Grasshopper



Exerc. 4.10 – Caramujo Grasshopper



# 5- Exercícios Corais



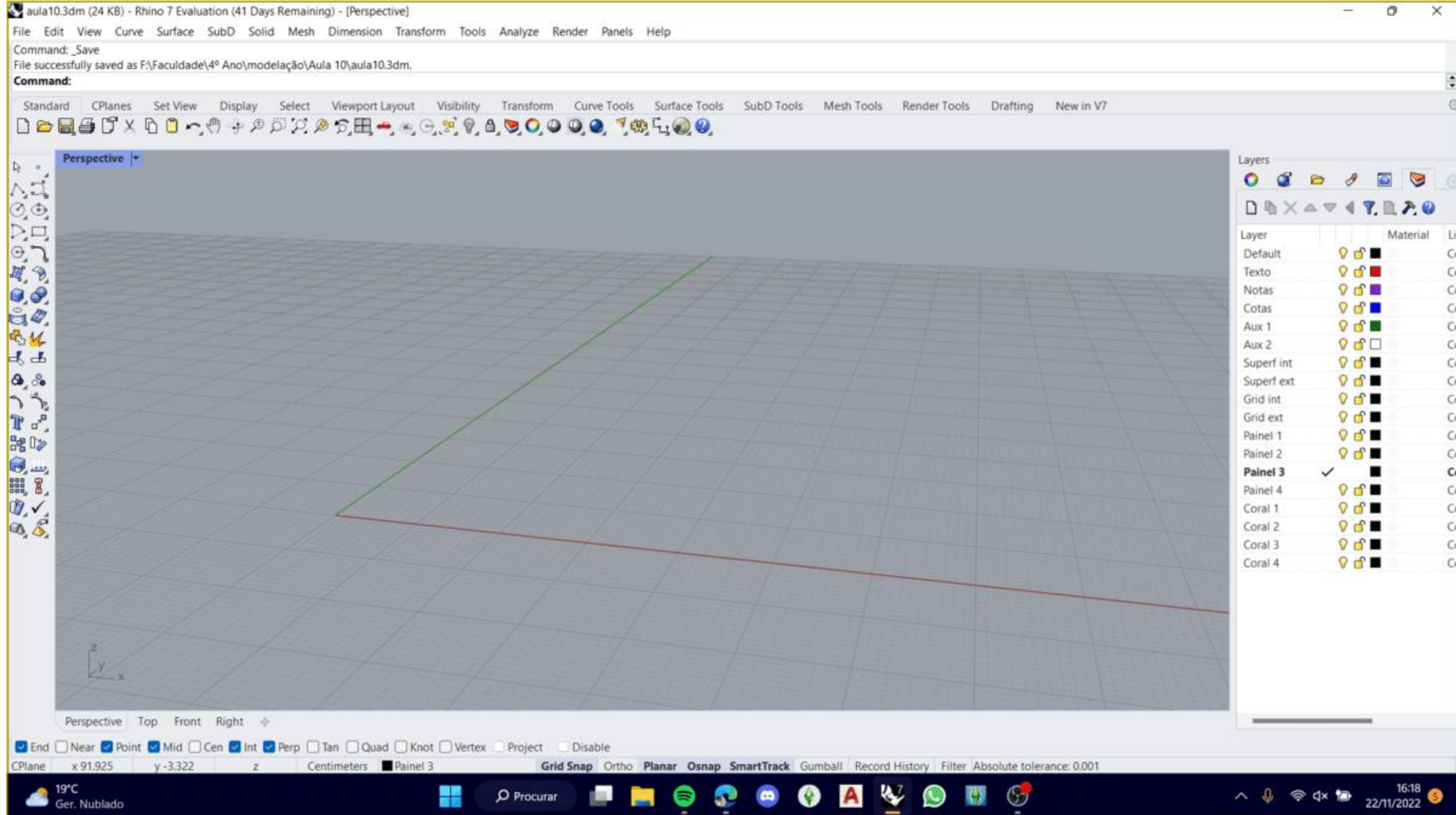

# Exerc. 5.1 – Coral espinhoso

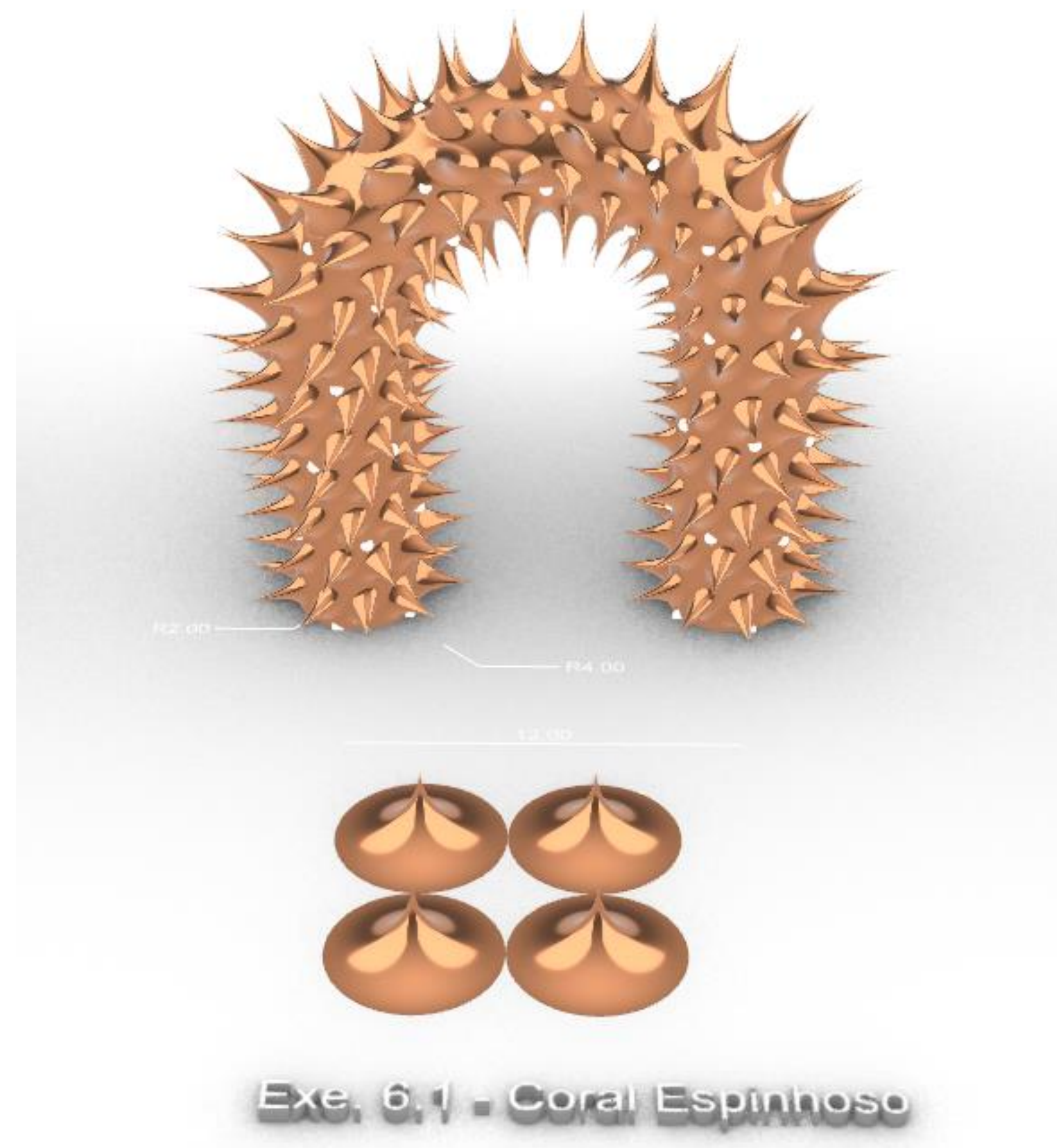

Exerc. 5.1 – Coral espinhoso



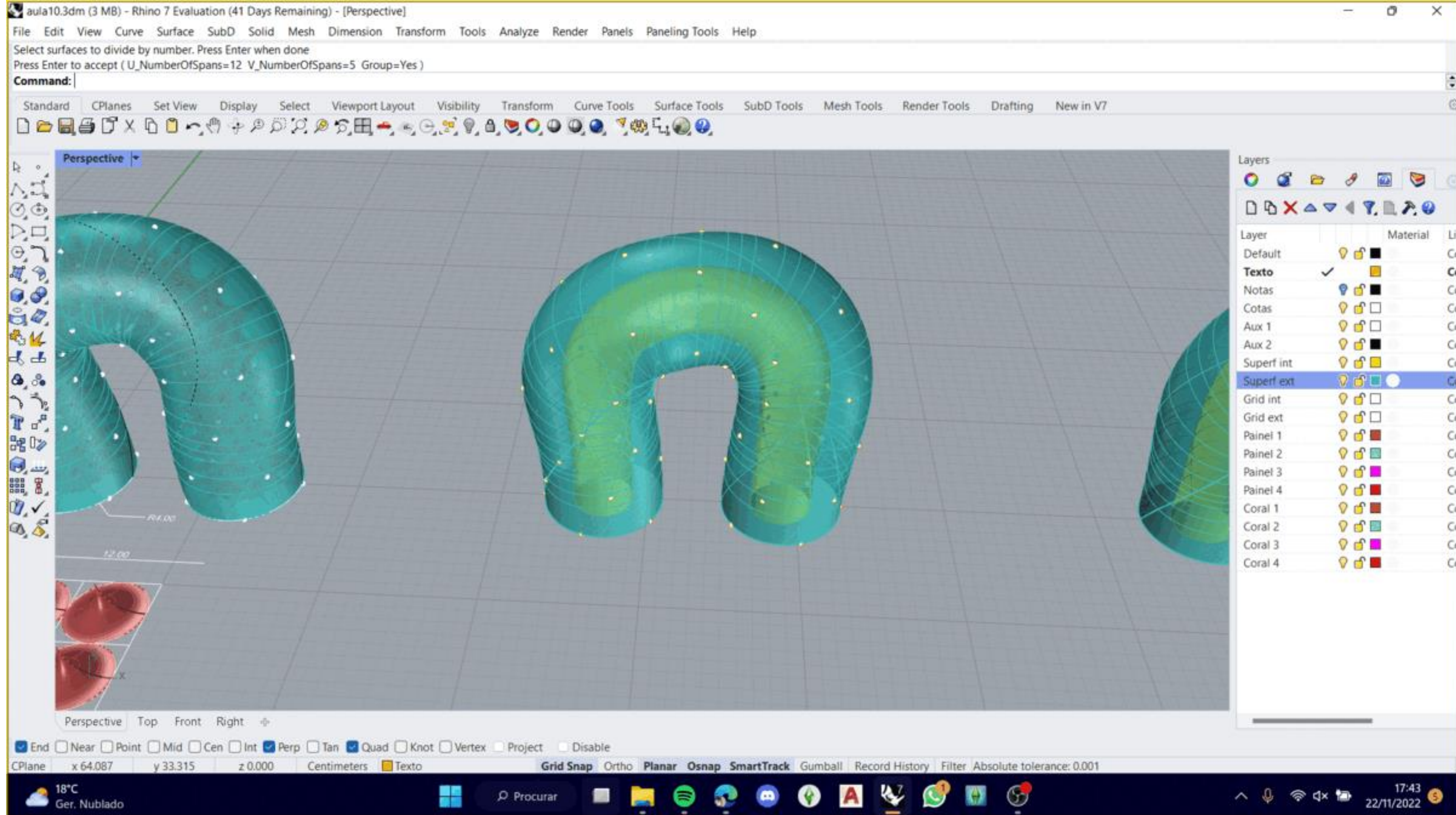

# Exerc. 5.2 – Coral octopussy

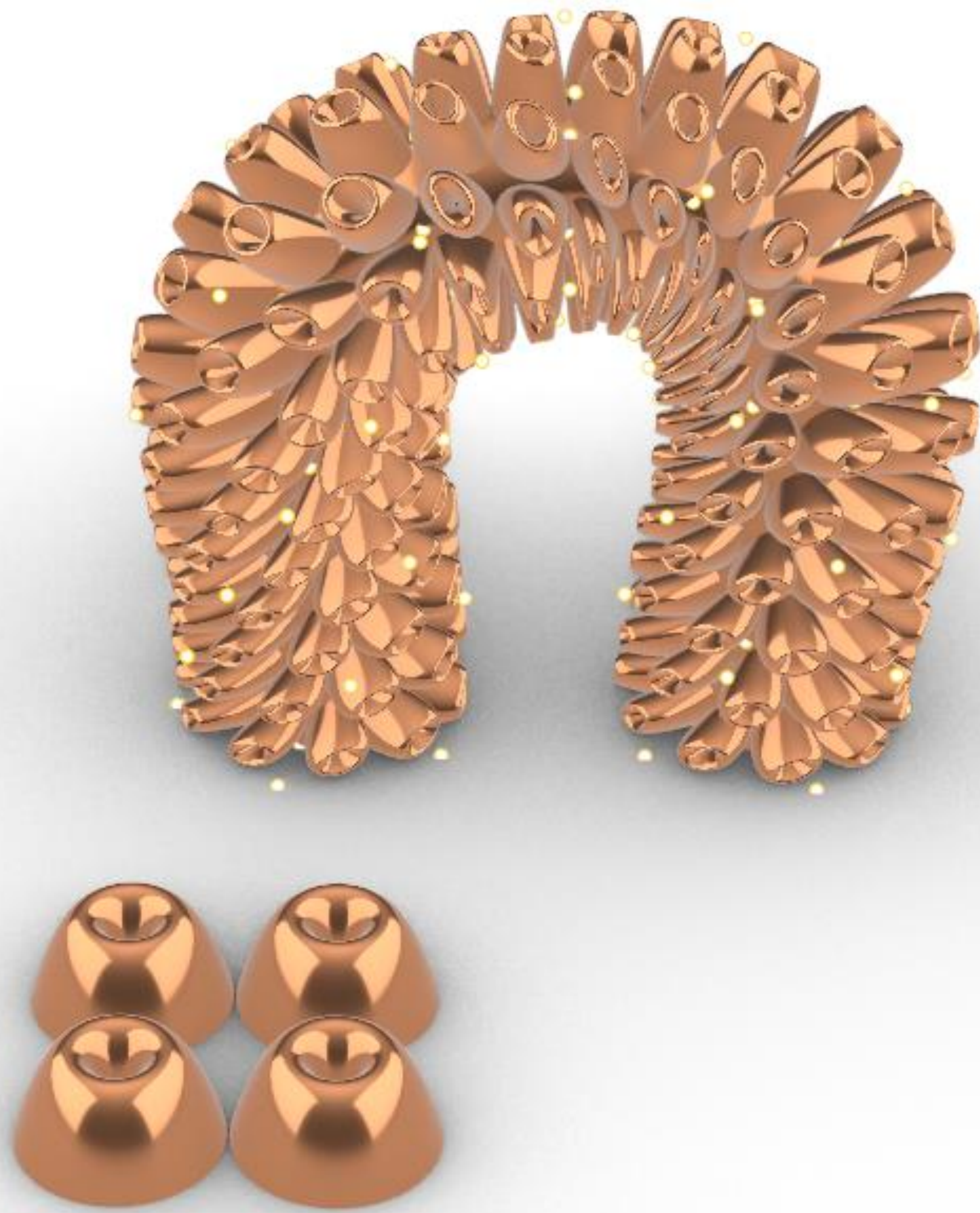

Exe, 6.2 - Coral Octopussy

Exerc. 5.2 – Coral octopussy

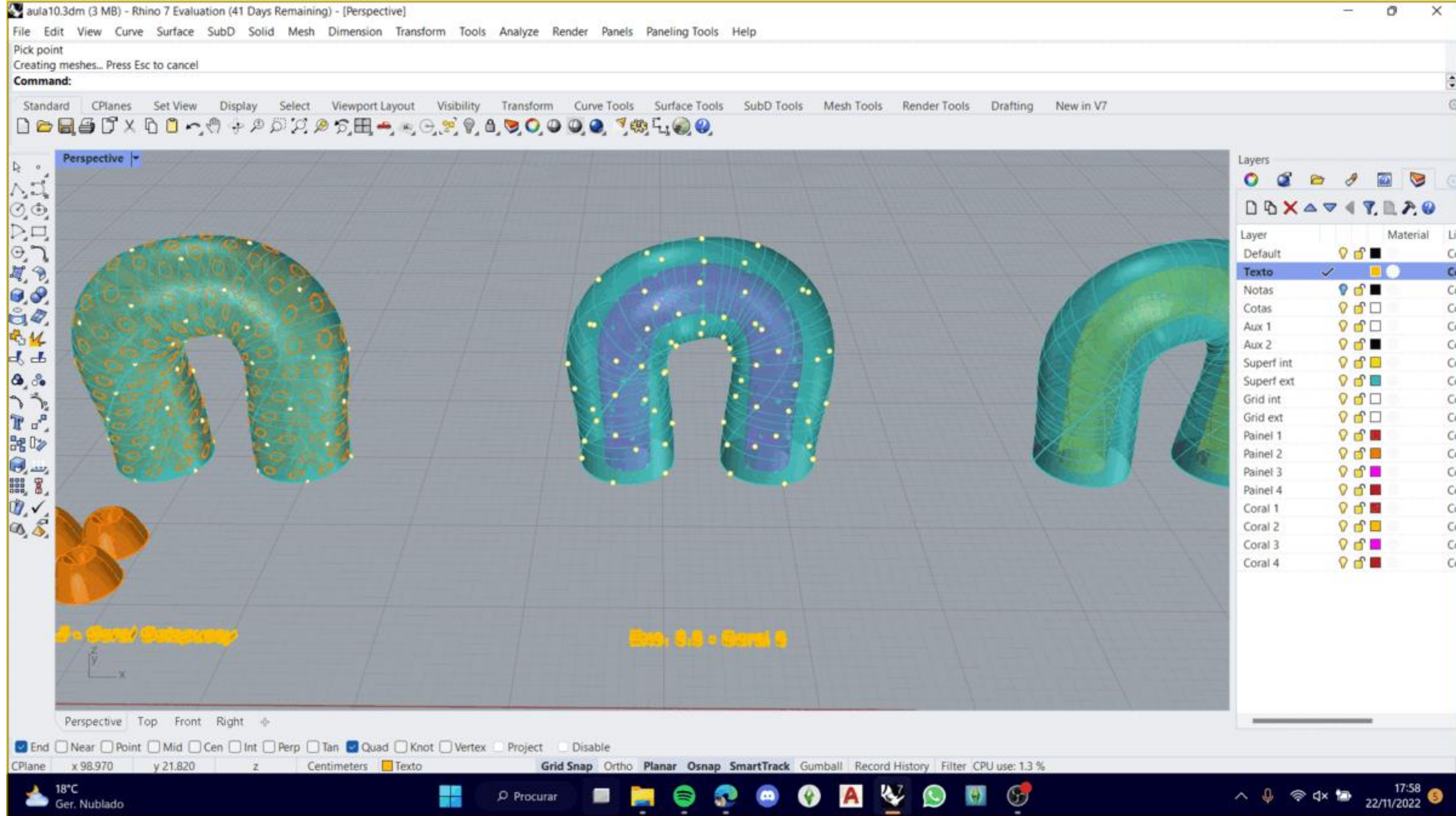

# Exerc. 5.3 – Coral ventosa

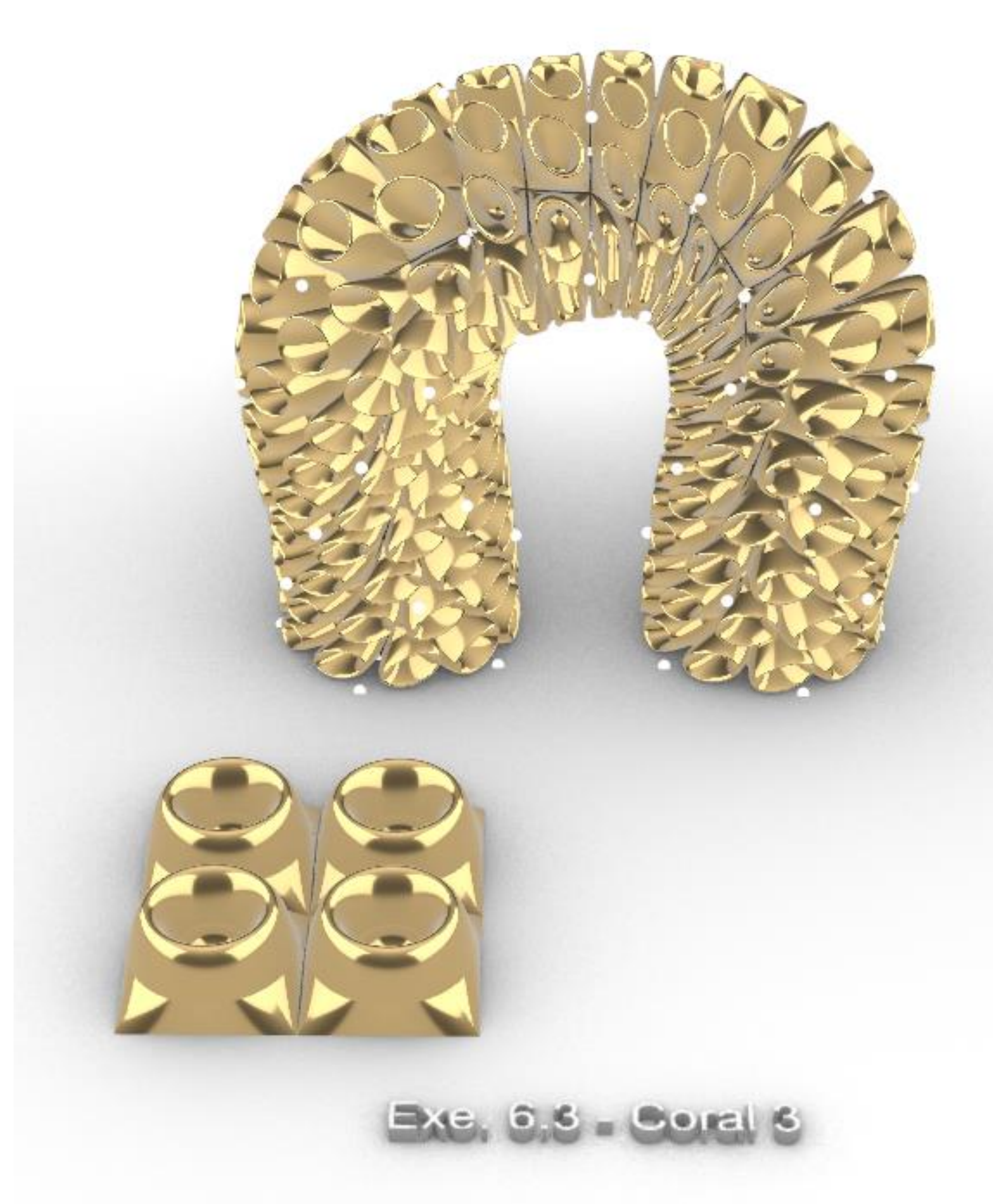

Exe. 6,3 - Coral 3

Exerc. 5.3 – Coral ventosa

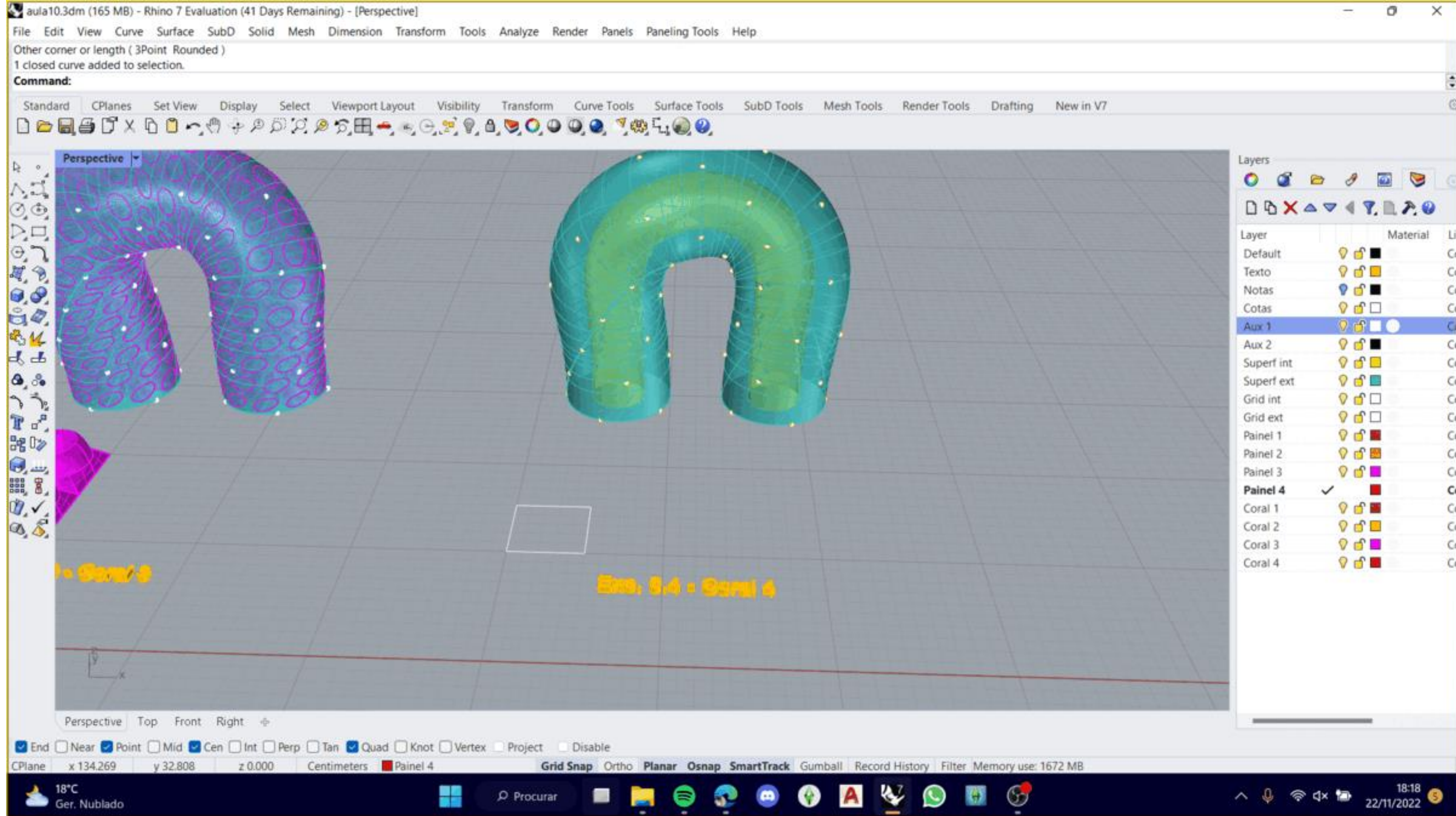

# Exerc. 5.4 – Coral espinhoso 2

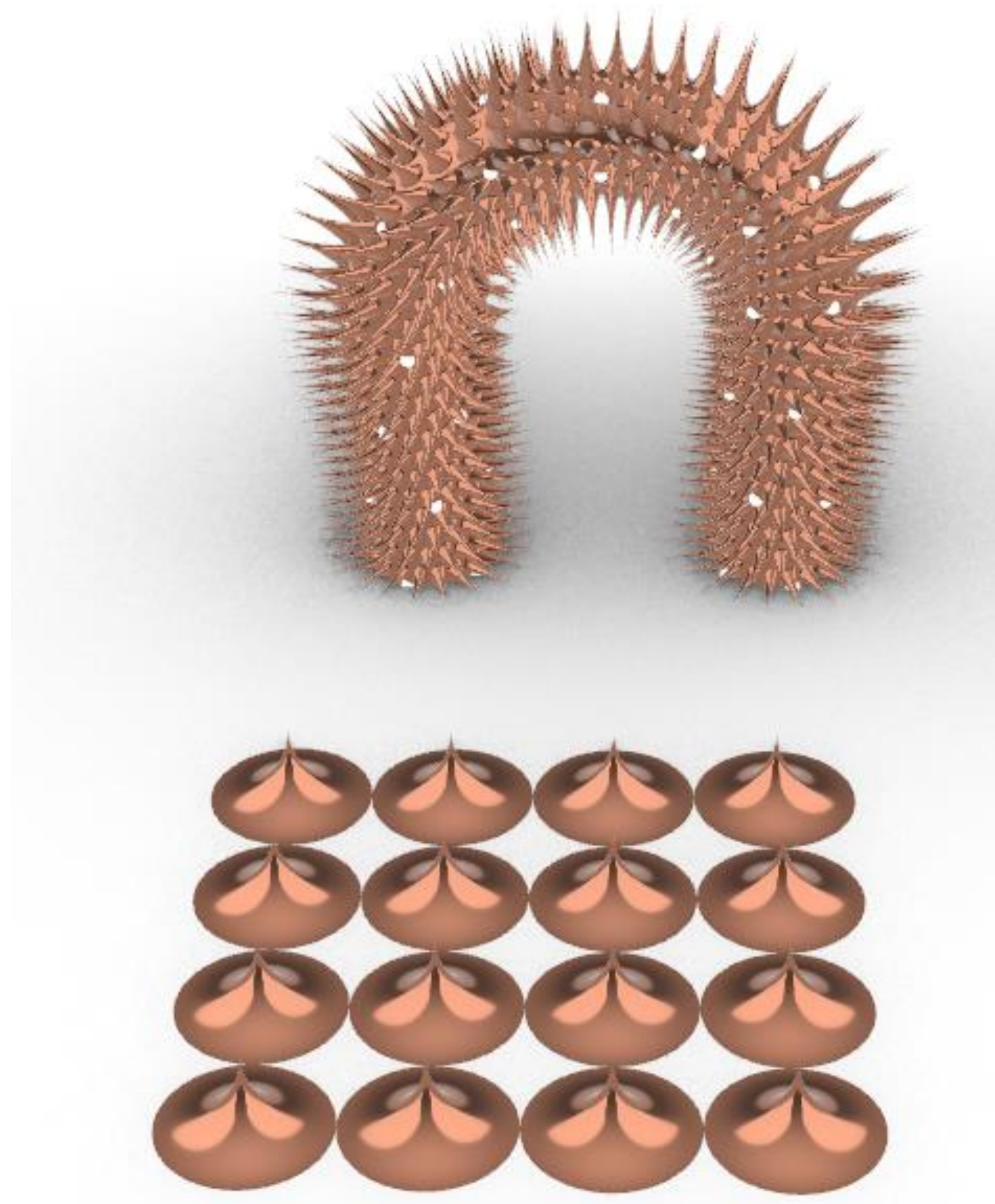

Exe. 6.4 - Coral 4

Exerc. 5.4 – Coral espinhoso 2



## 6- Exercício Anêmona

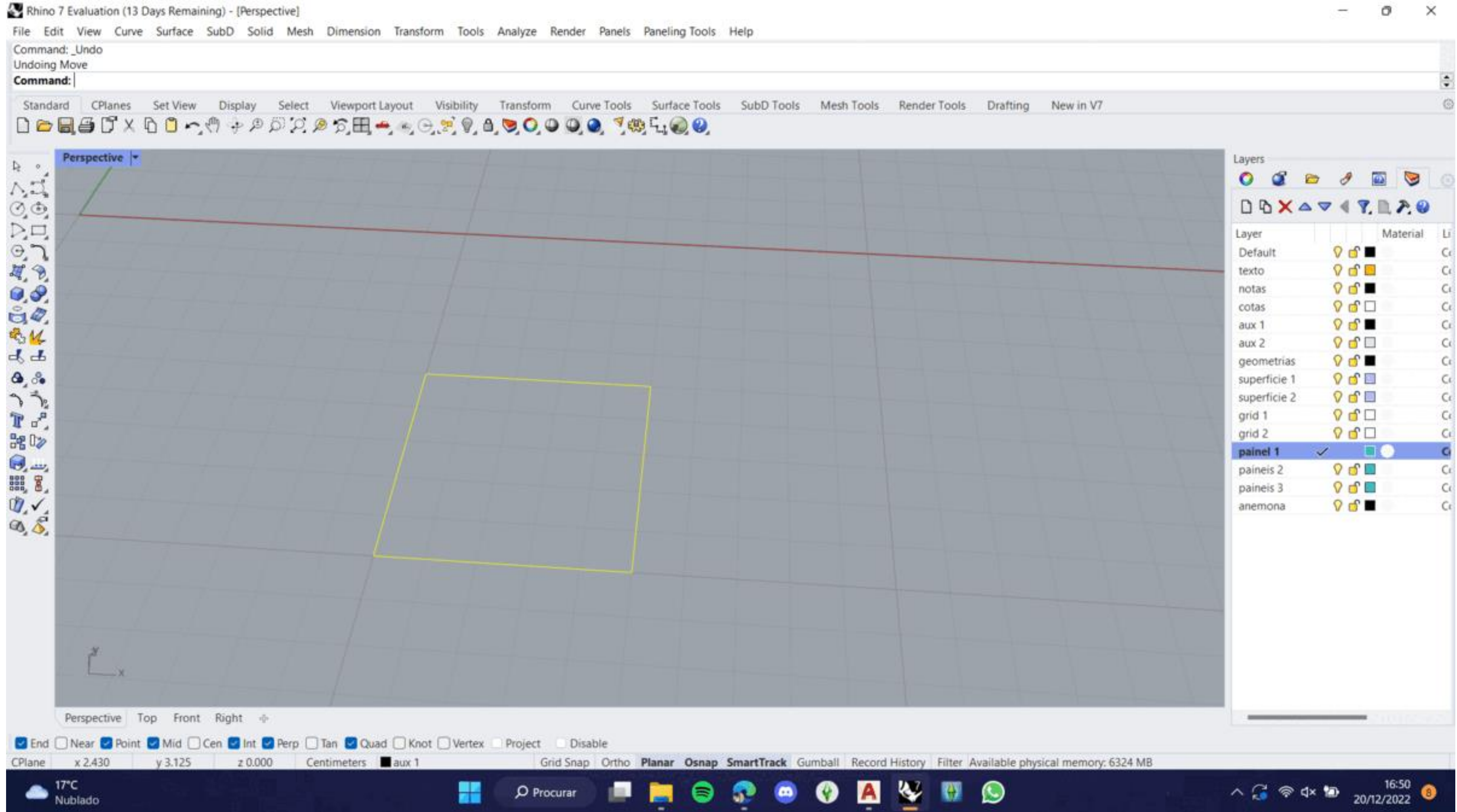

# Exerc. 6.1 - Anêmona



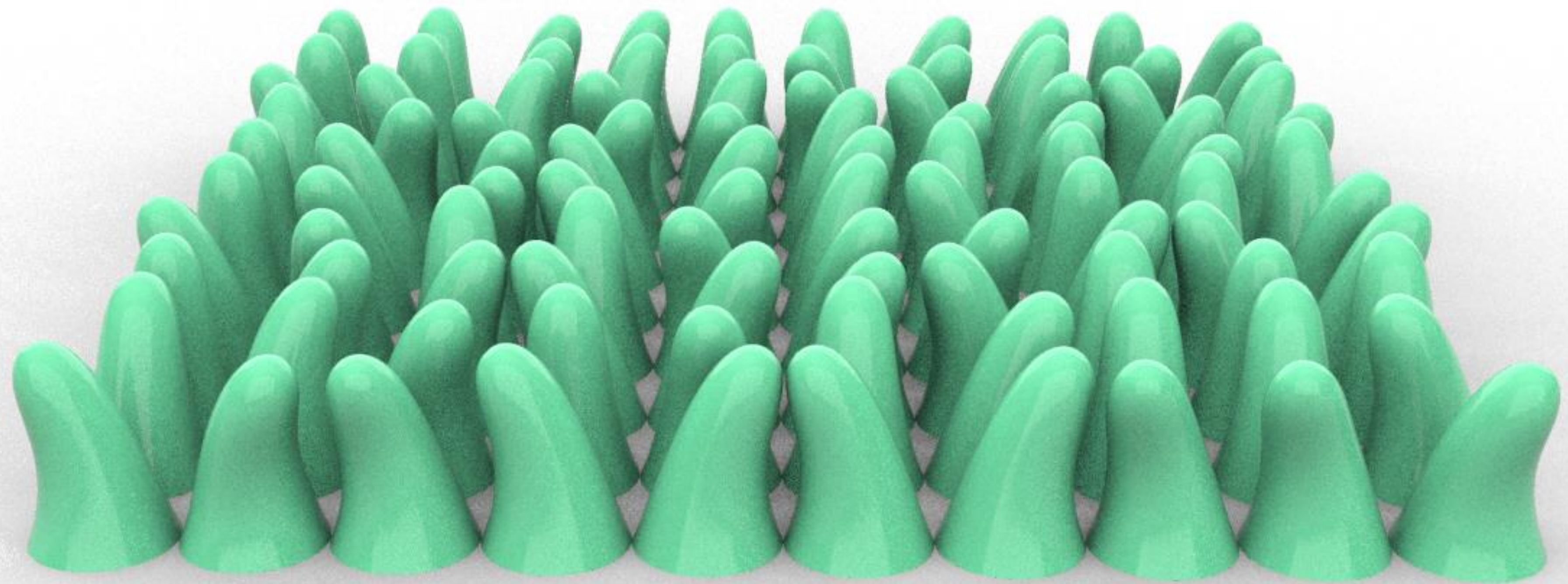

Exerc. 6.1 - Anêmona



# 7- Exercícios Abóbadas



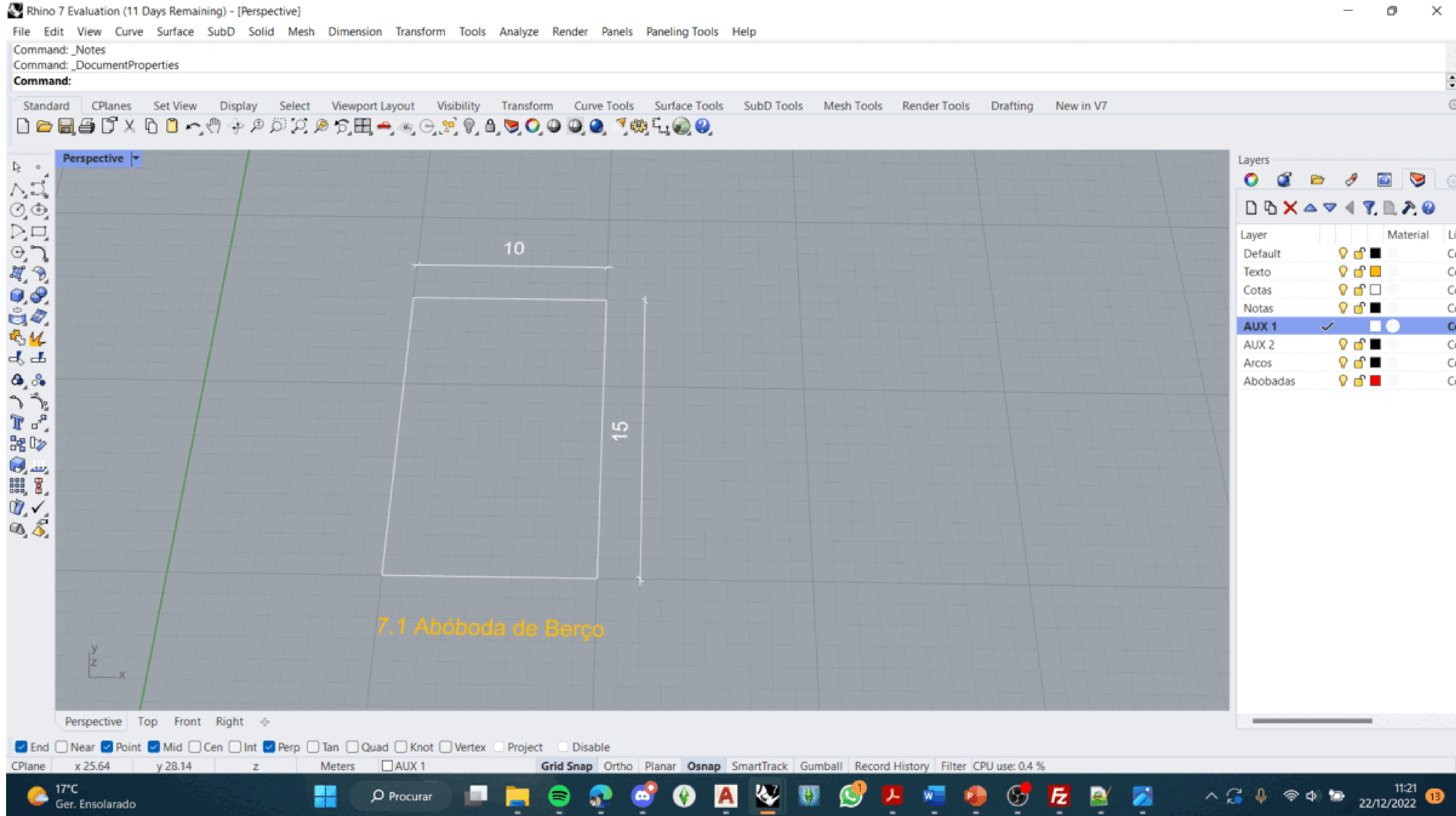

# Exerc. 7.1 – Abóboda de berço

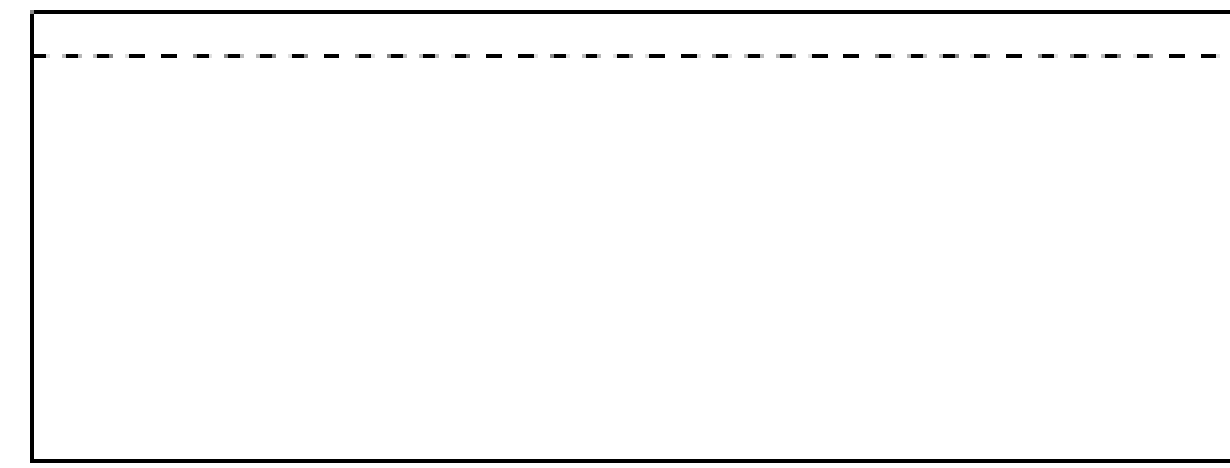
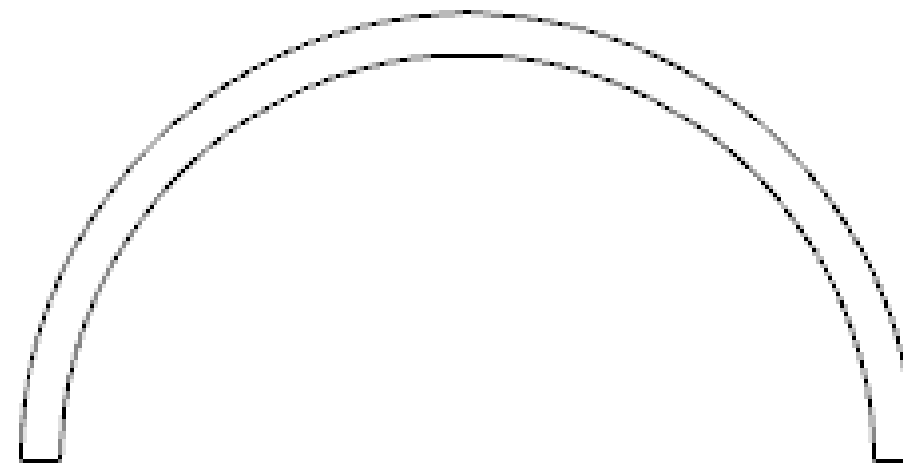
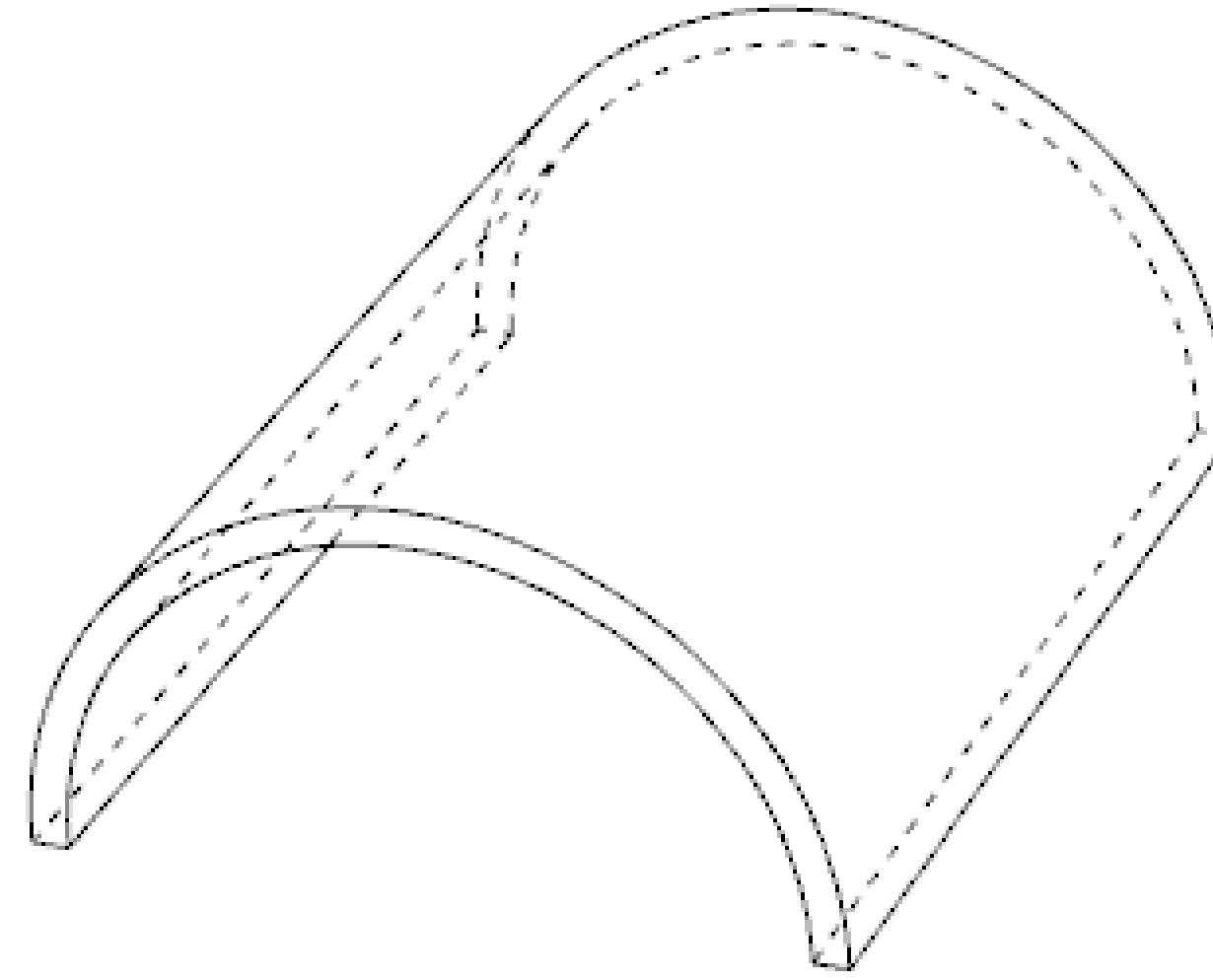
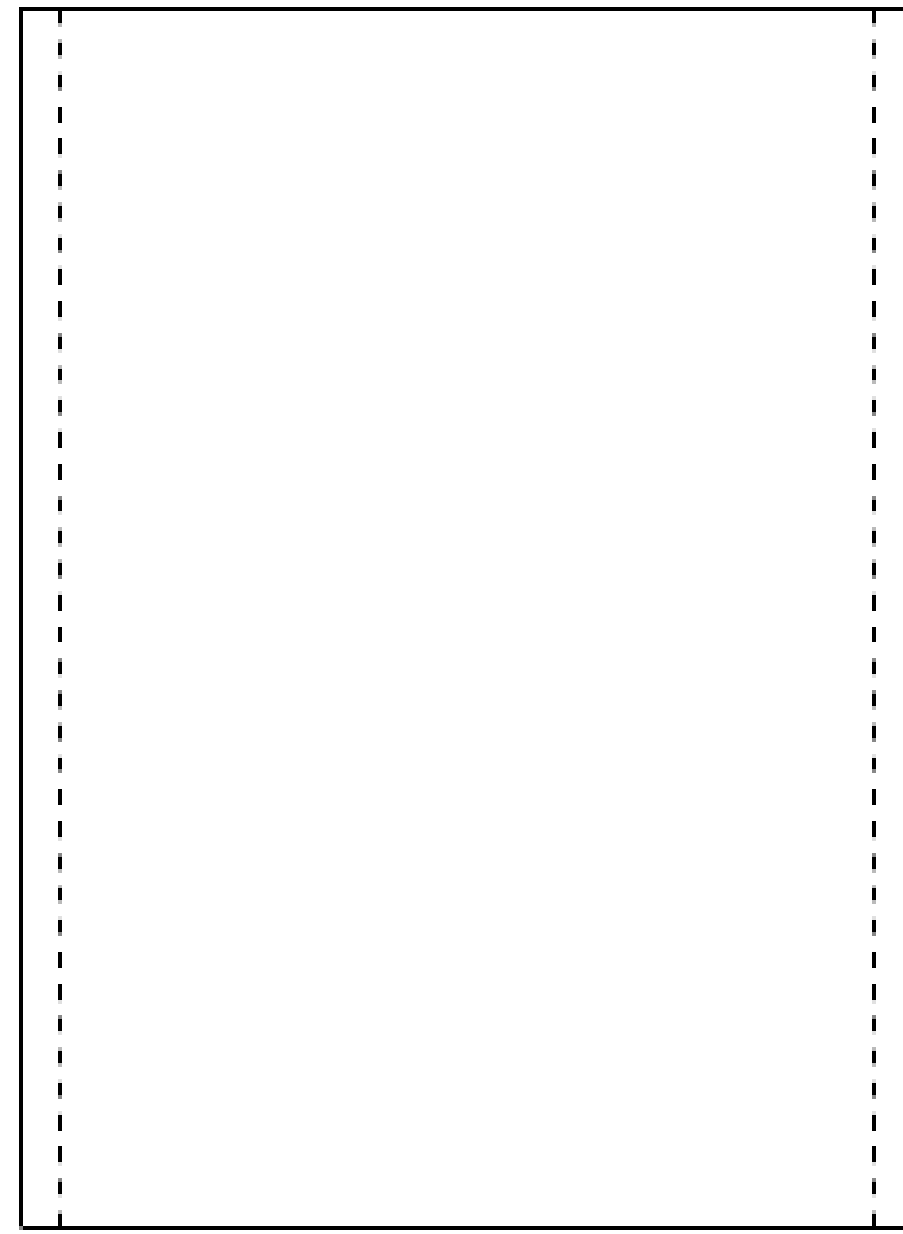

Exerc. 7.1 – Abóbada de berço

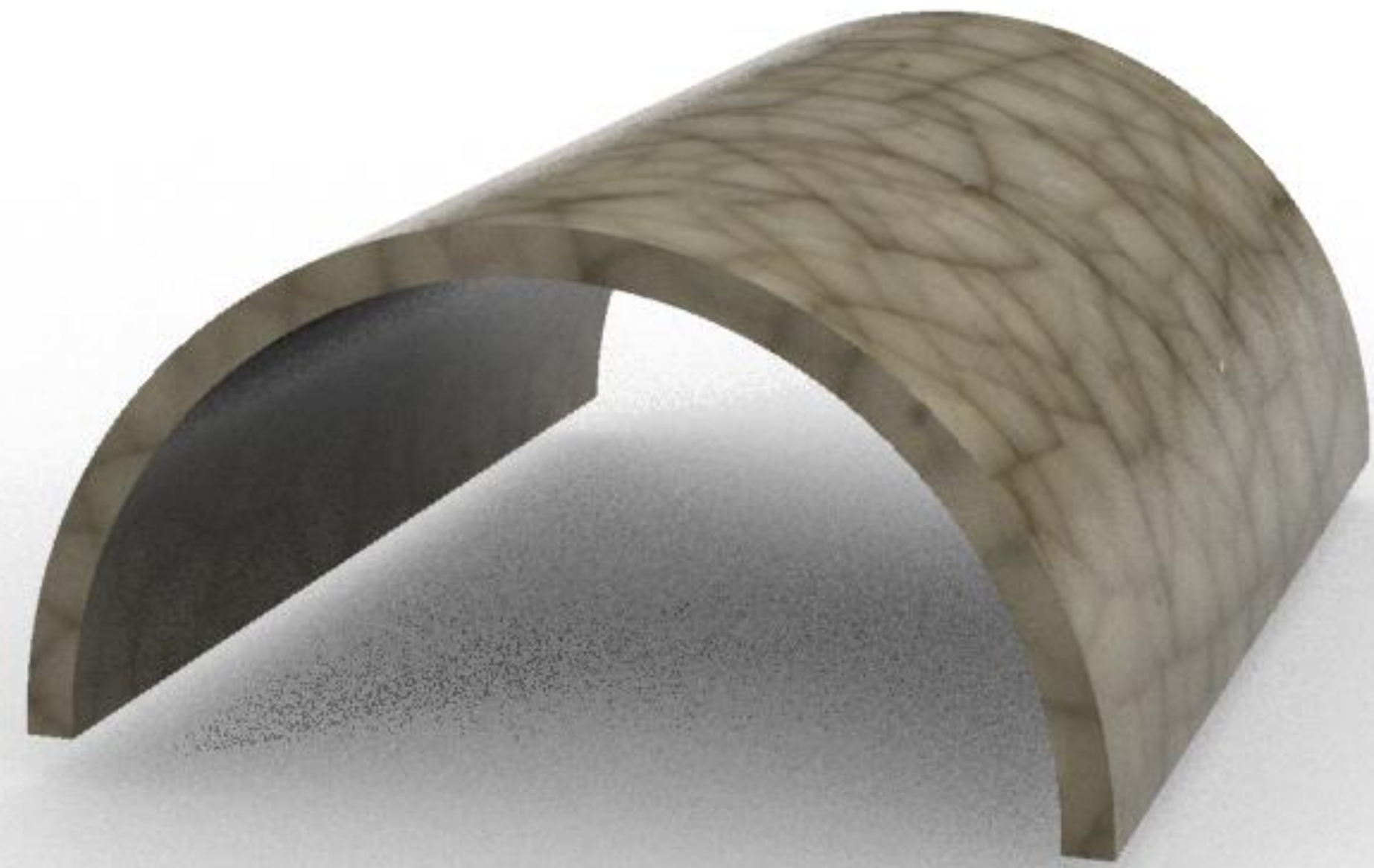

Exerc. 7.1 – Abóbada de berço

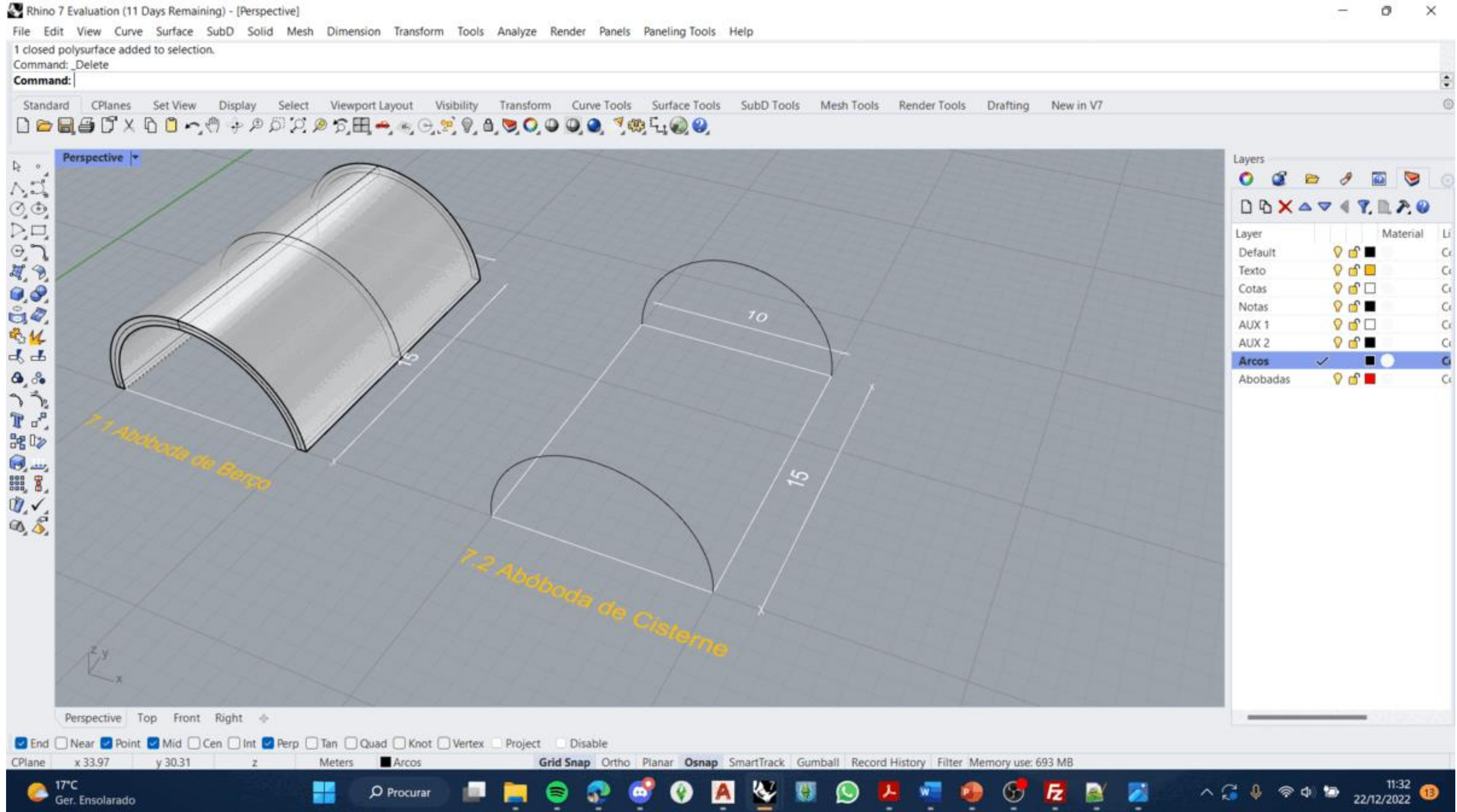

# Exerc. 7.2 – Abóbada de cisterna

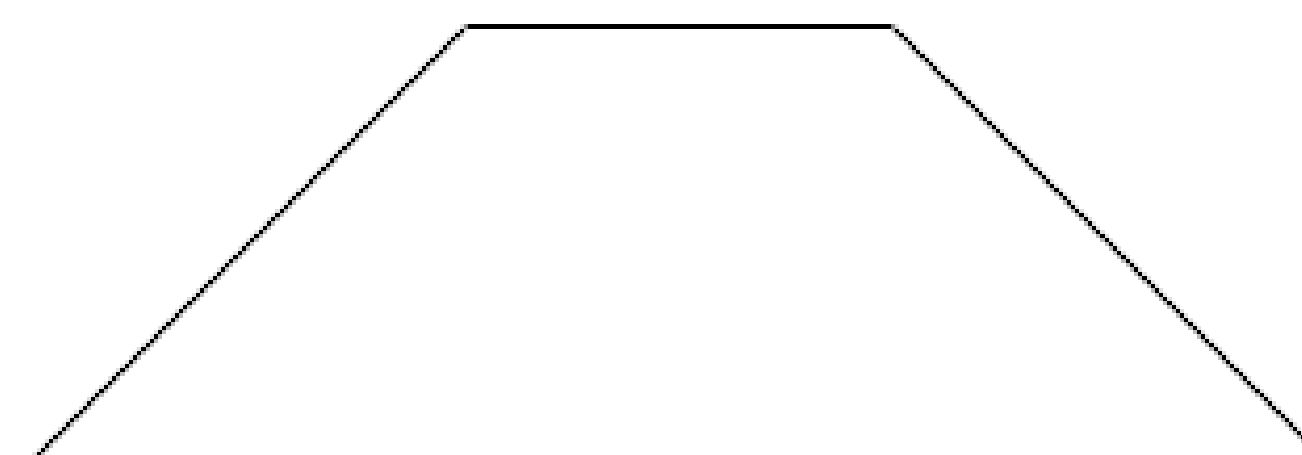
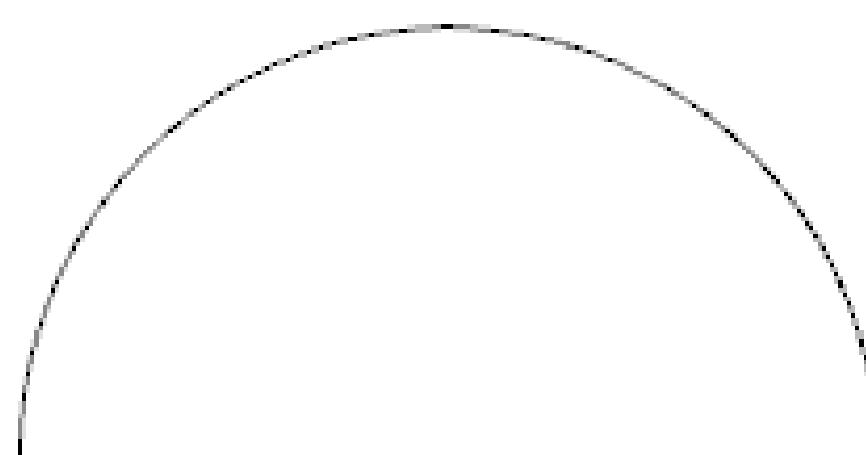
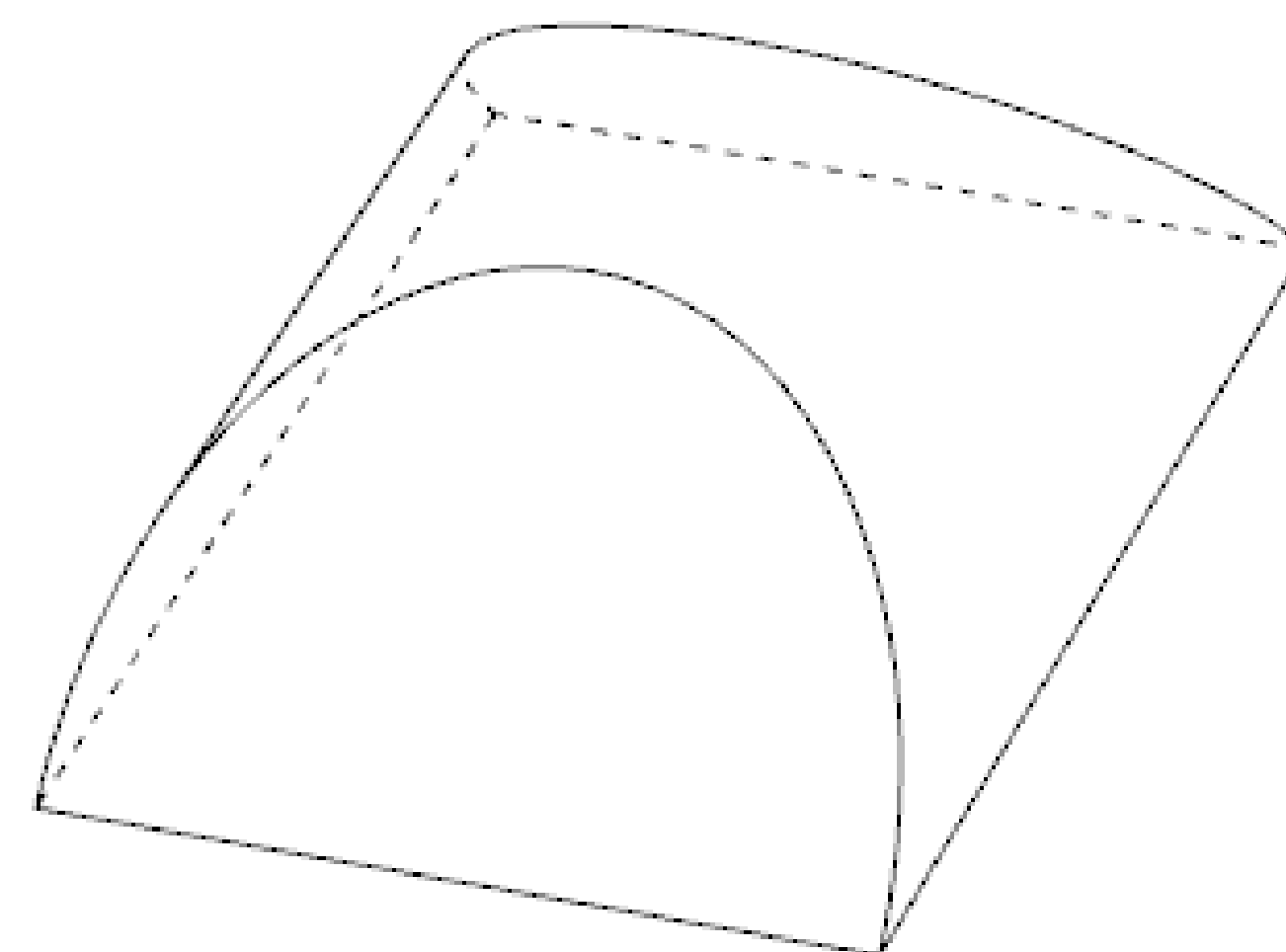
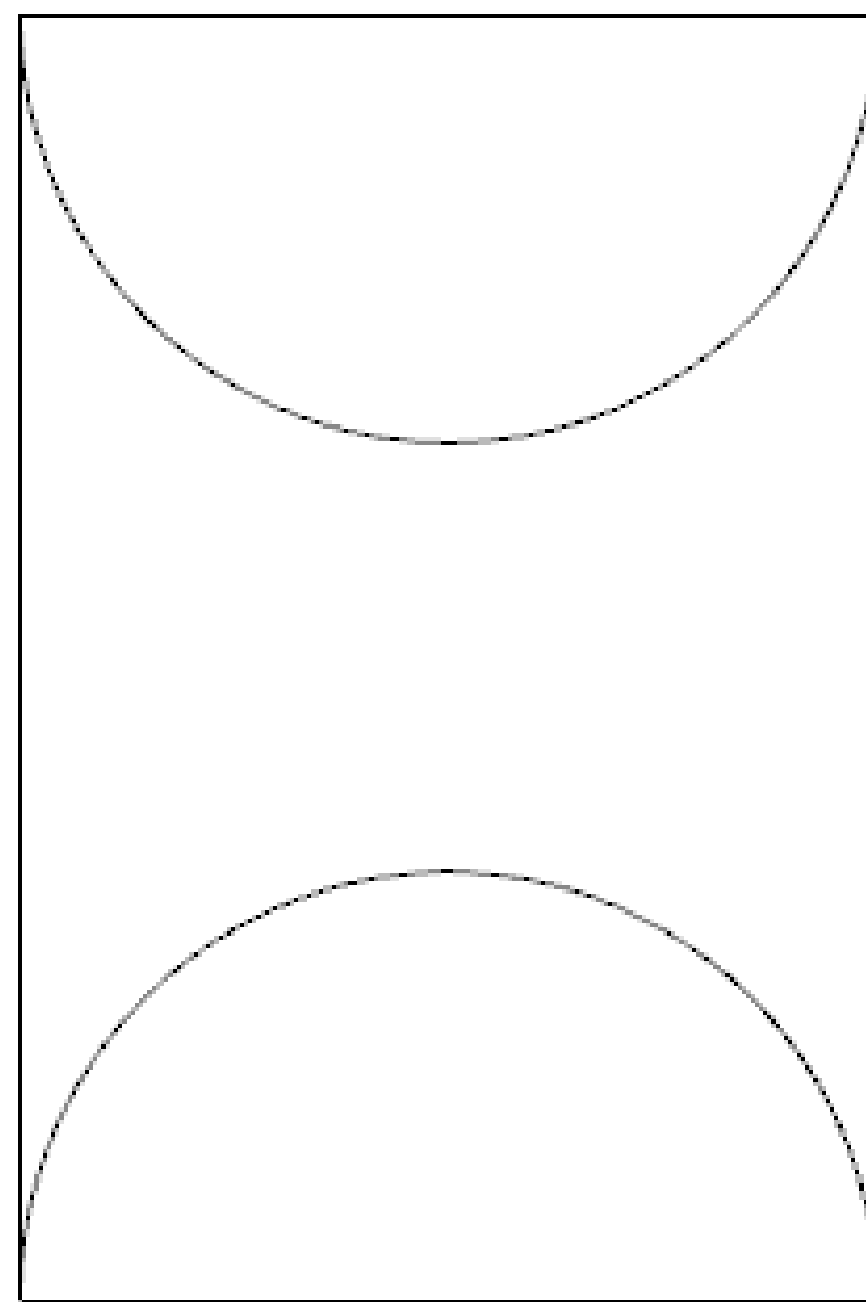

Exerc. 7.2 – Abóbada de cisterna



Exerc. 7.2 – Abóbada de cisterna



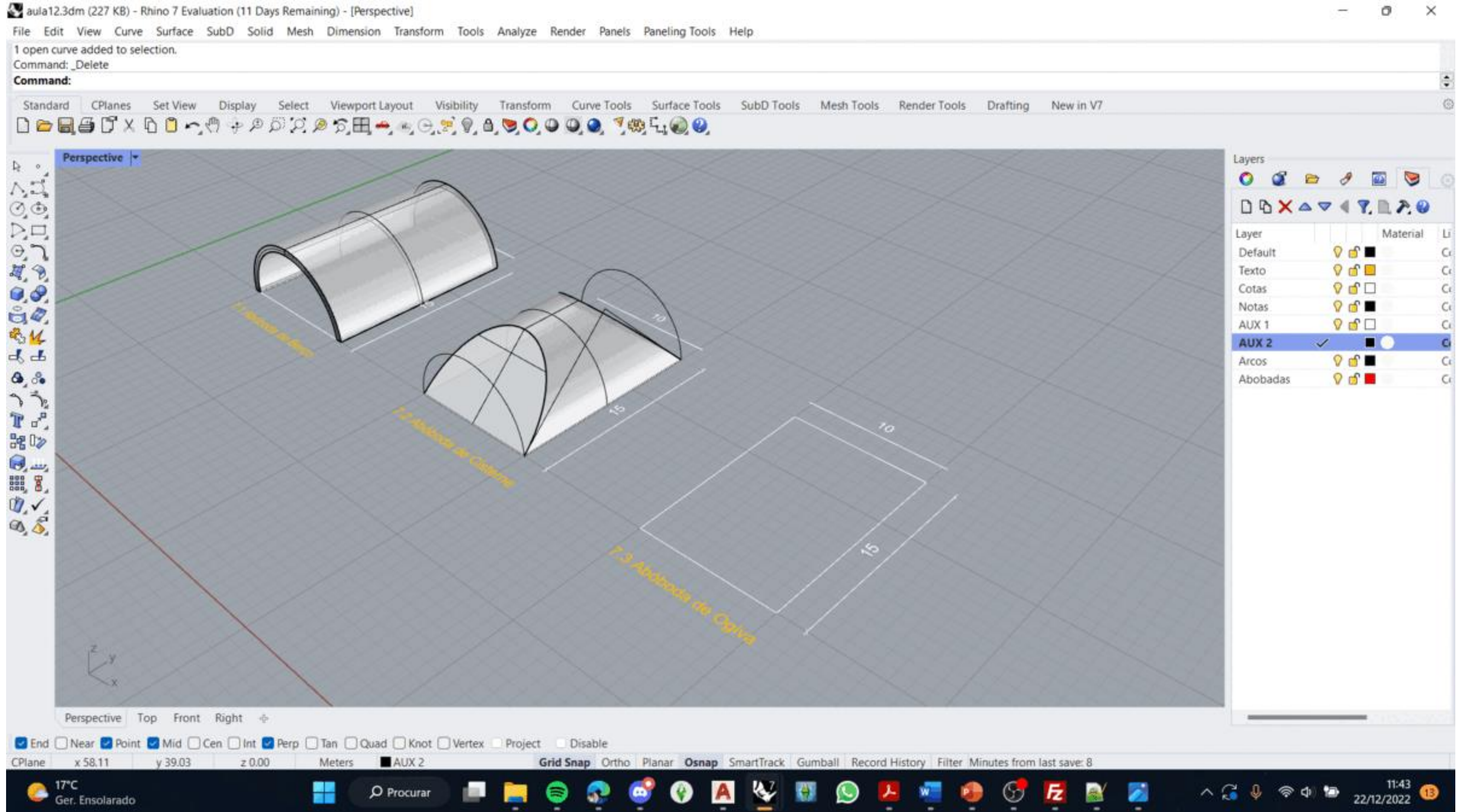

# Exerc. 7.3 – Abóbada de ogiva

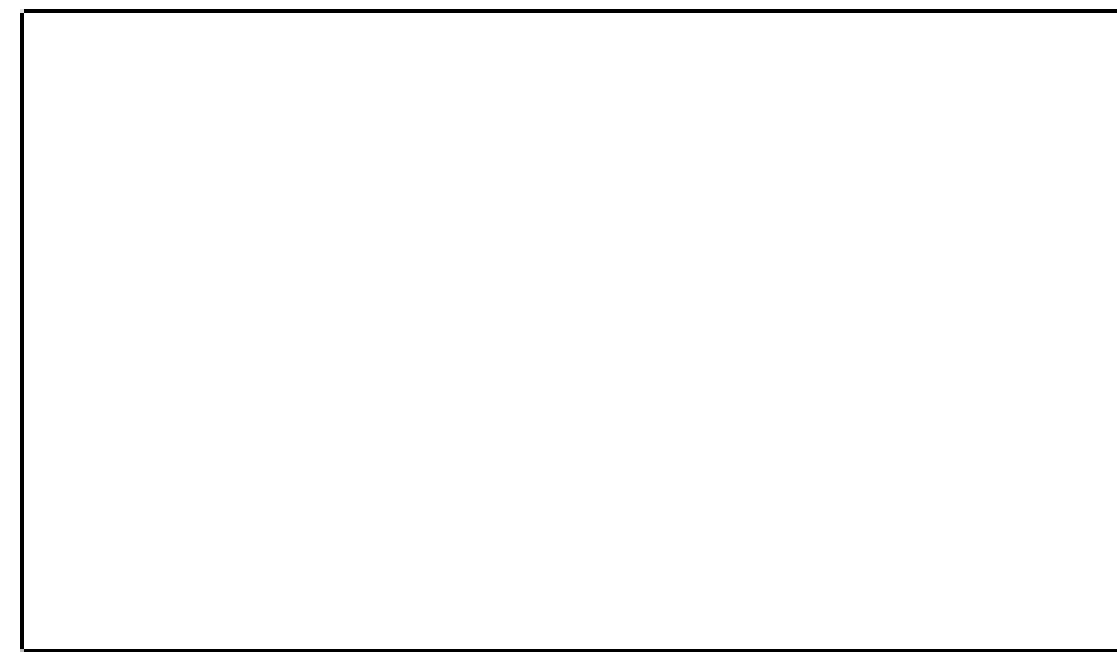
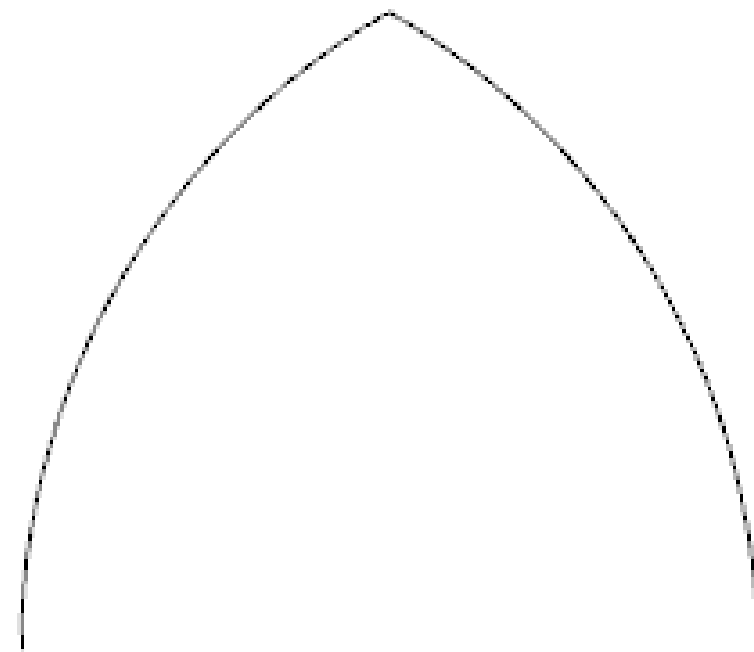
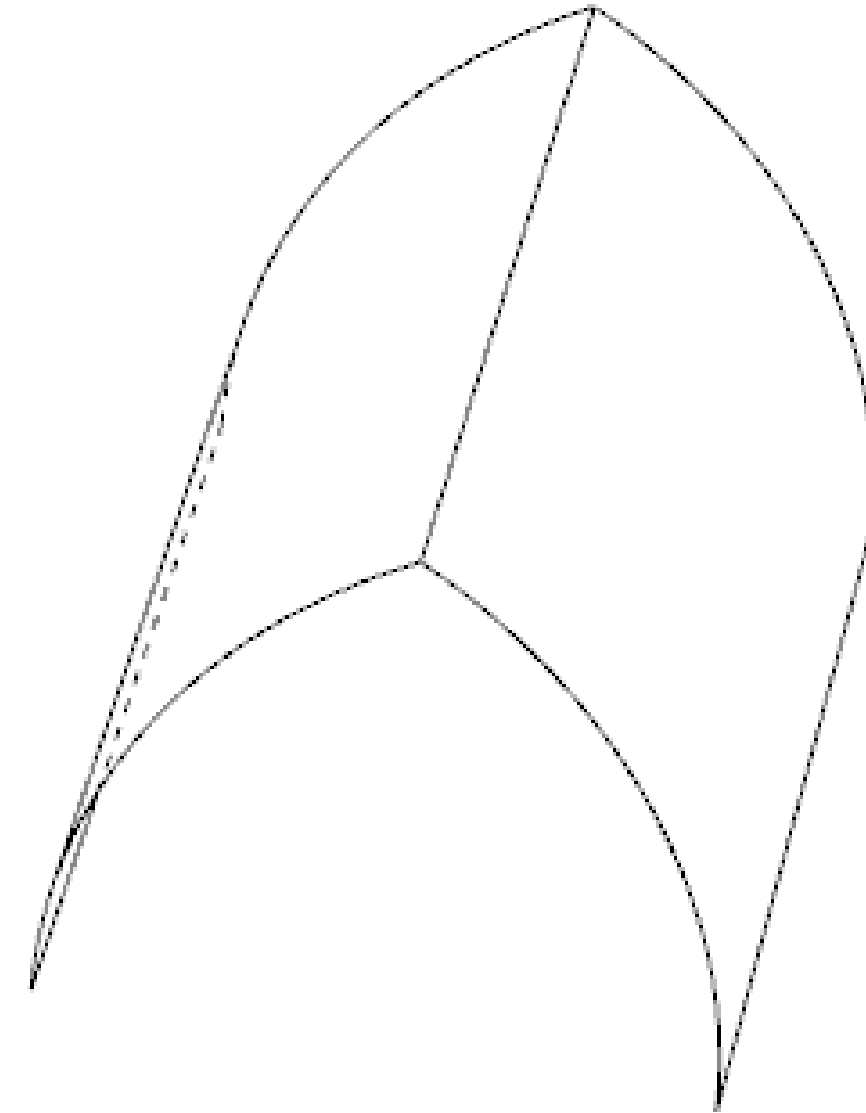
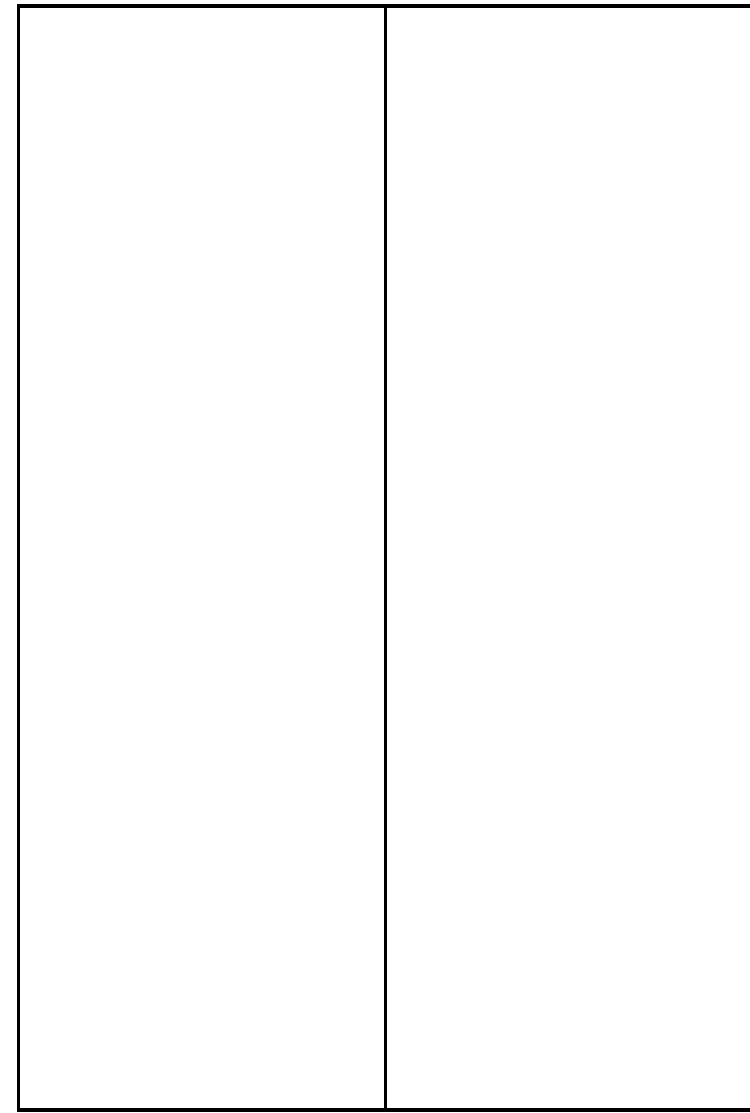

Exerc. 7.3 – Abóbada de ogiva

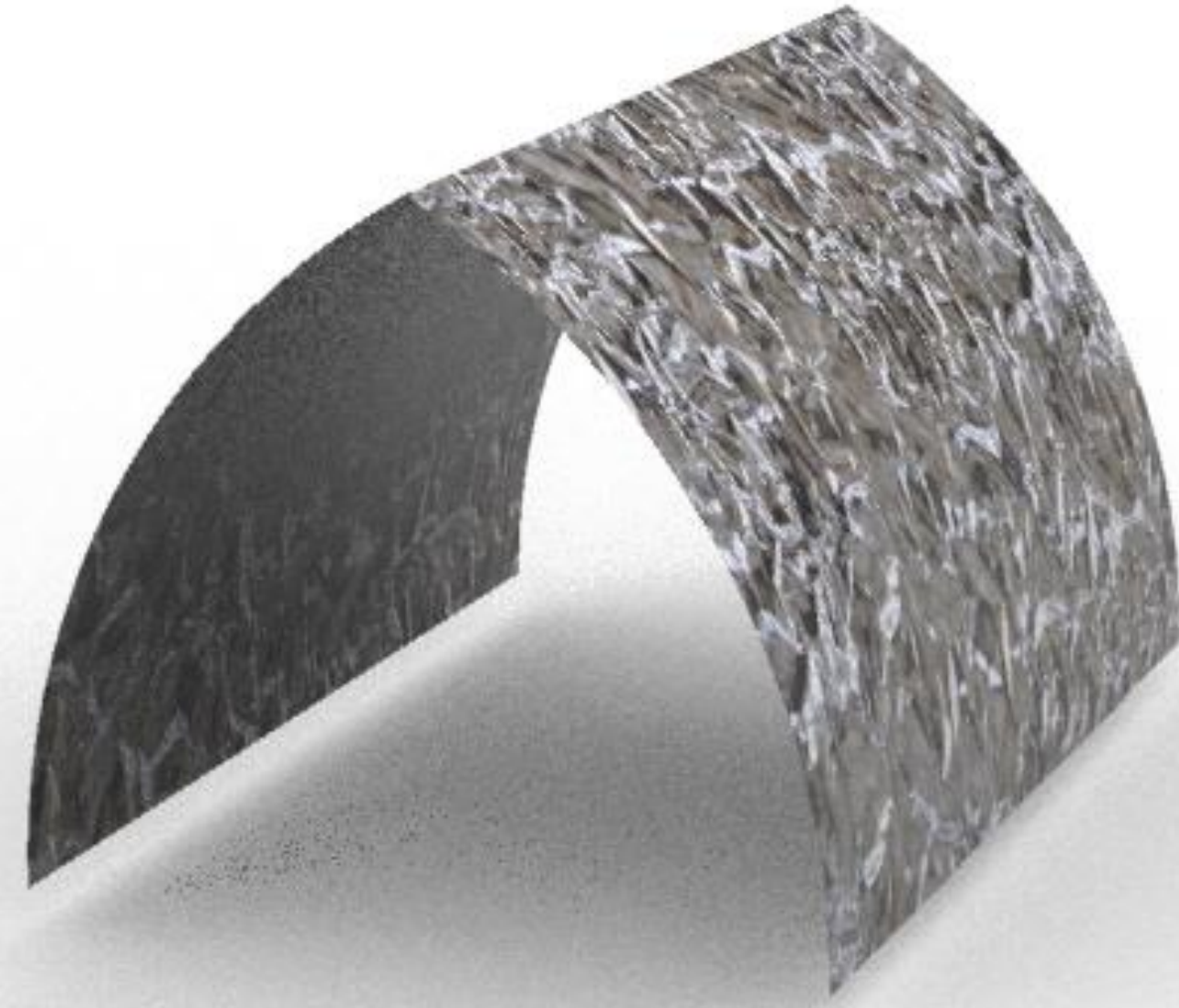

Exerc. 7.3 – Abóbada de ogiva

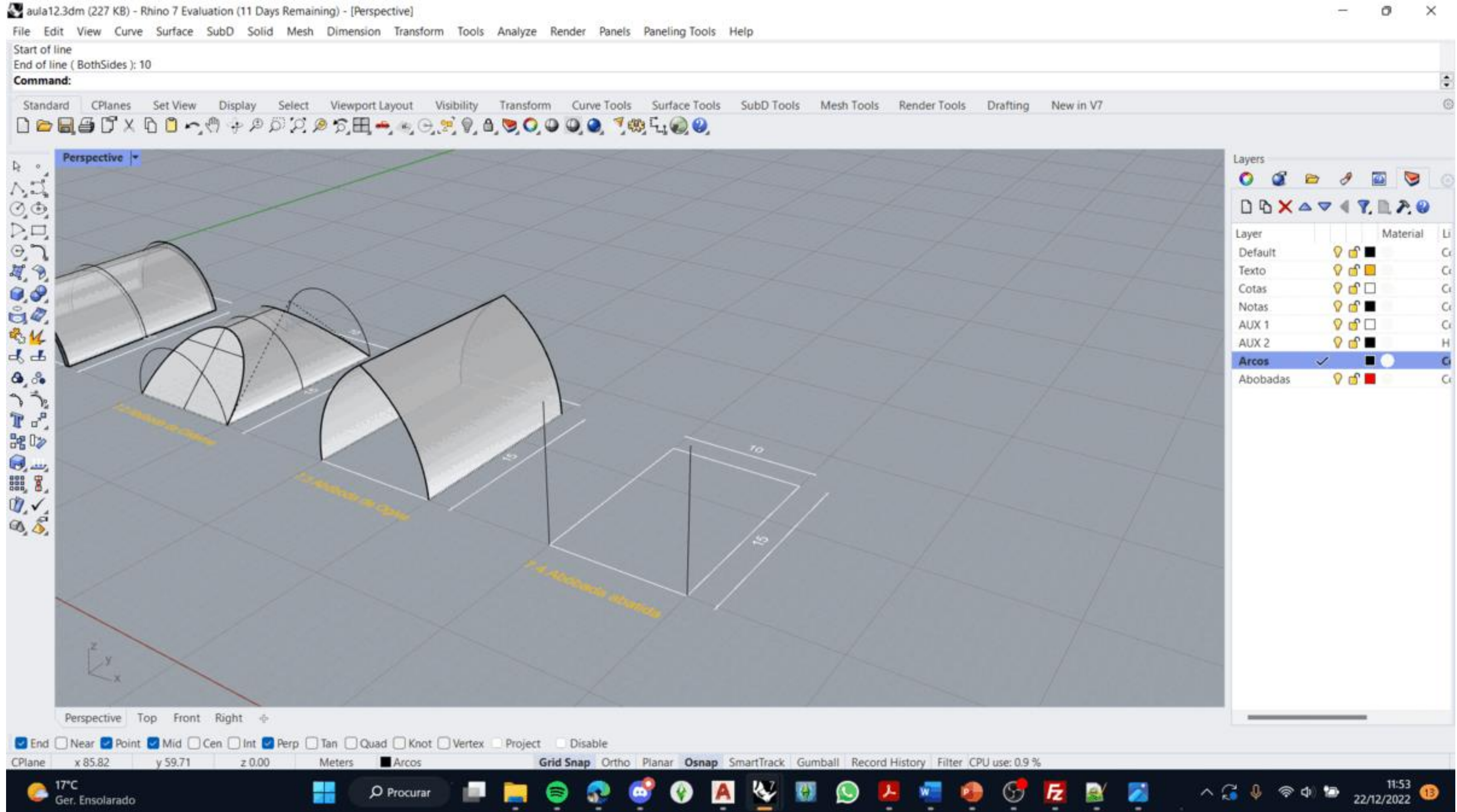

# Exerc. 7.4 – Abóbada abatida

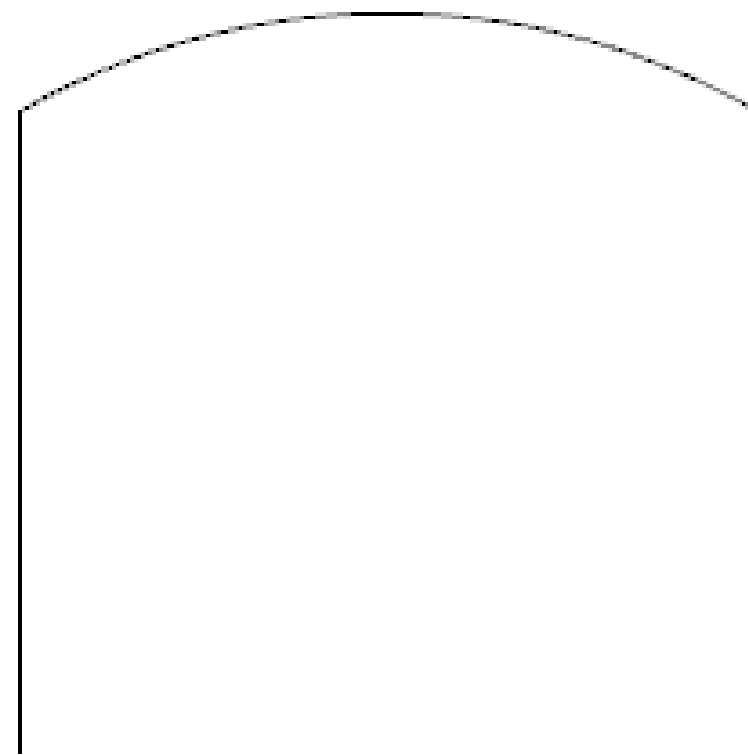
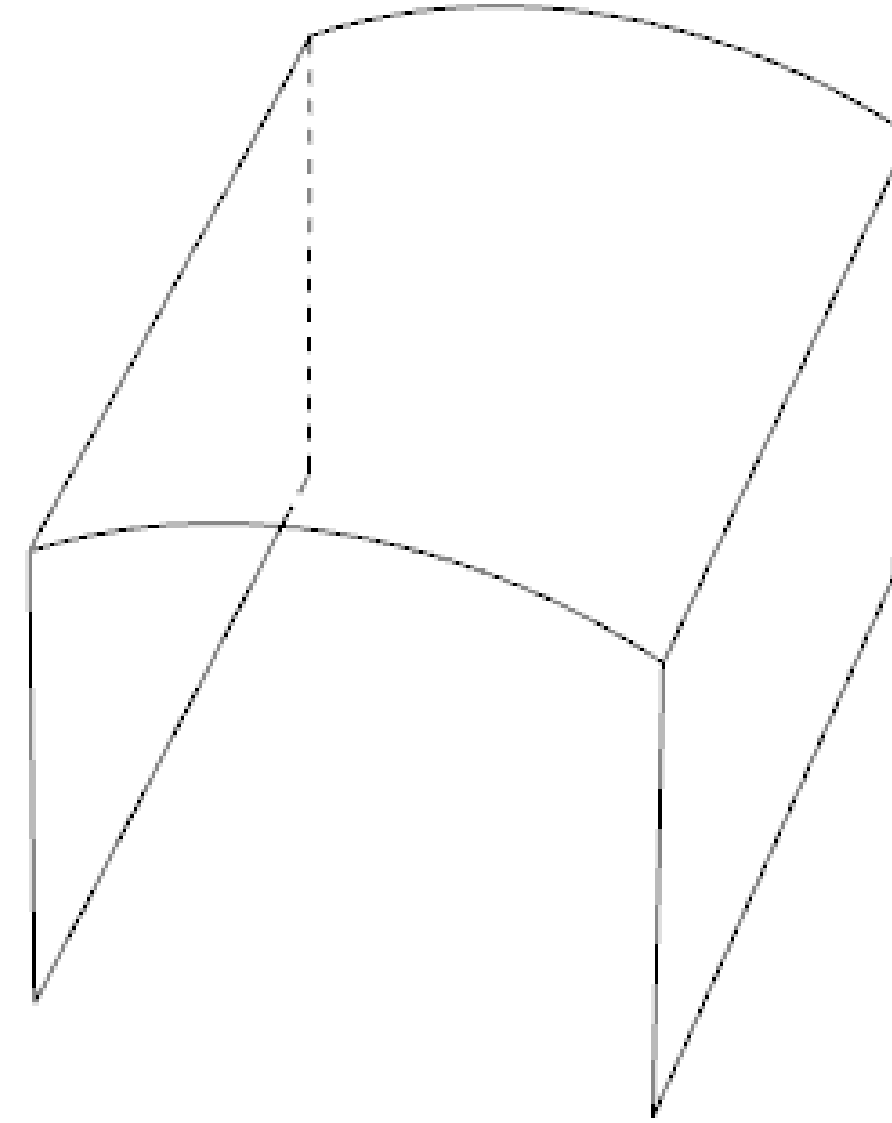
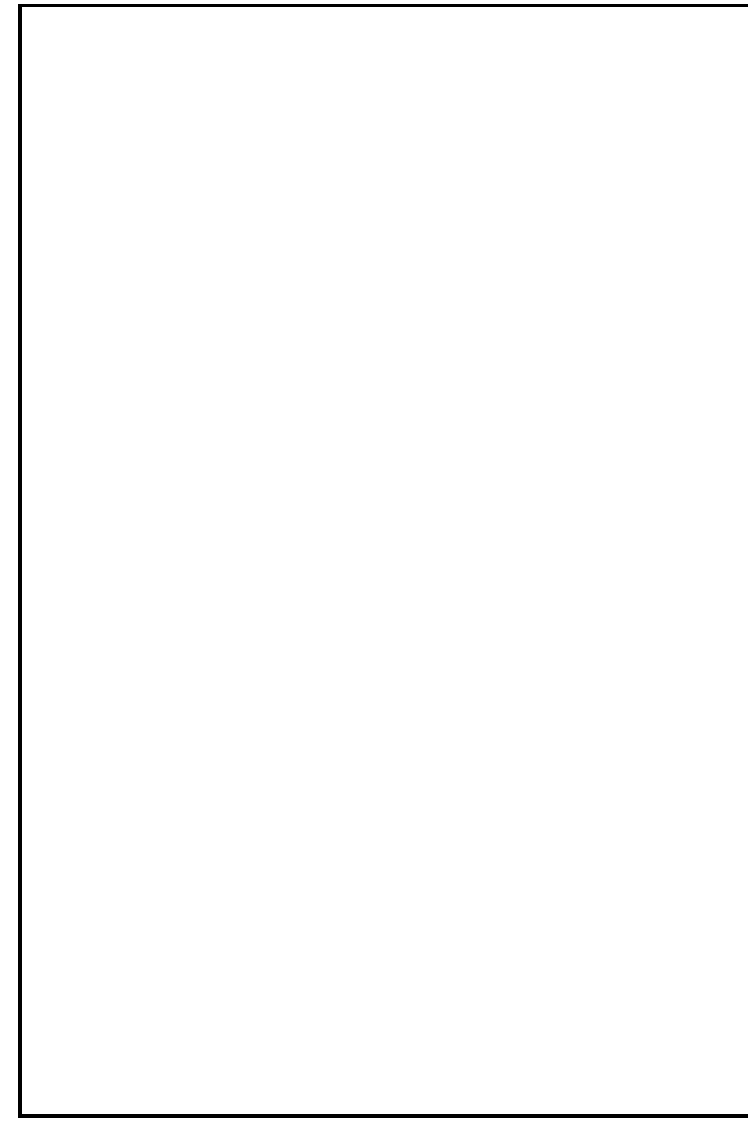

Exerc. 7.4 – Abóbada abatida

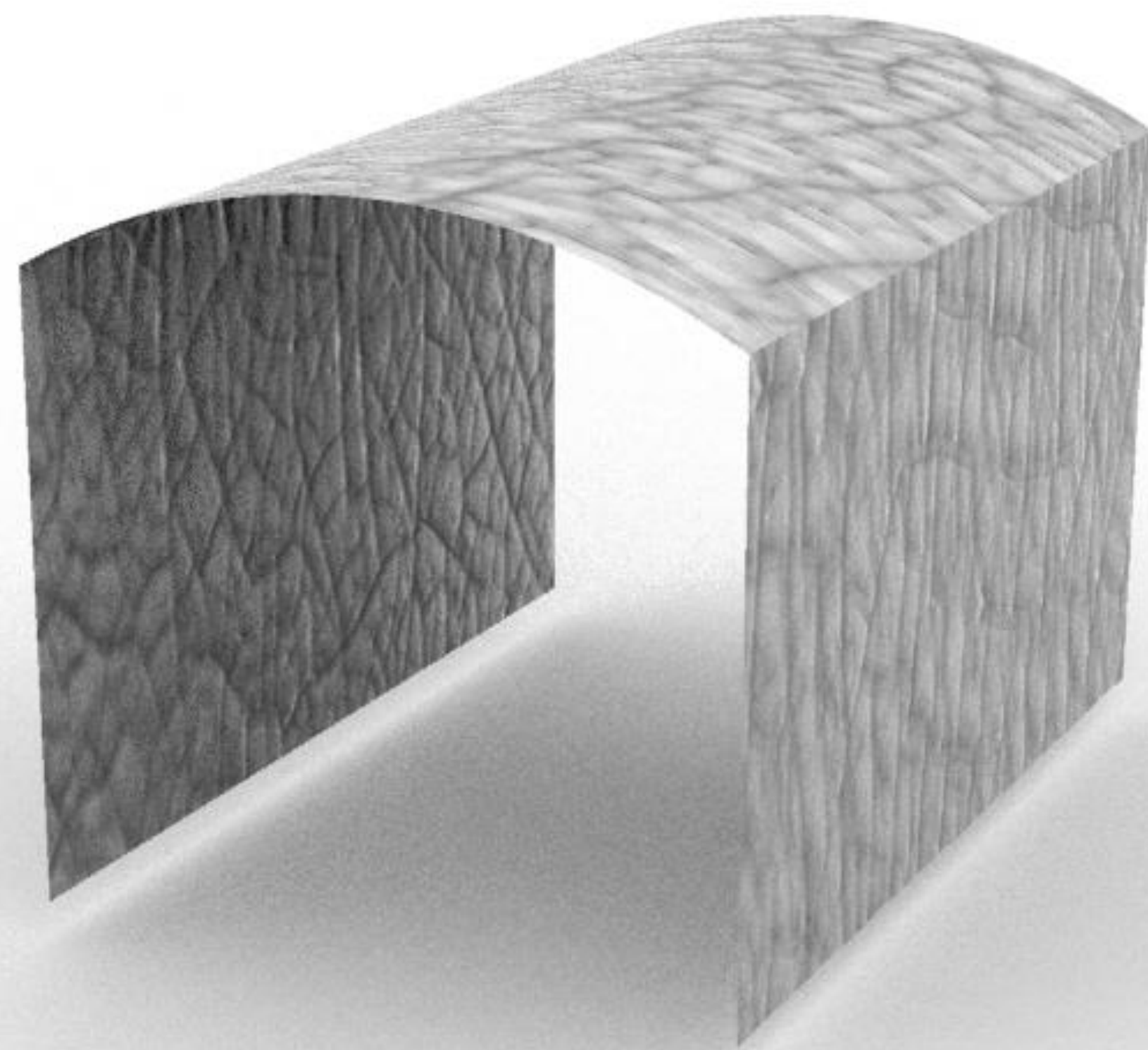

Exerc. 7.4 – Abóbada abatida

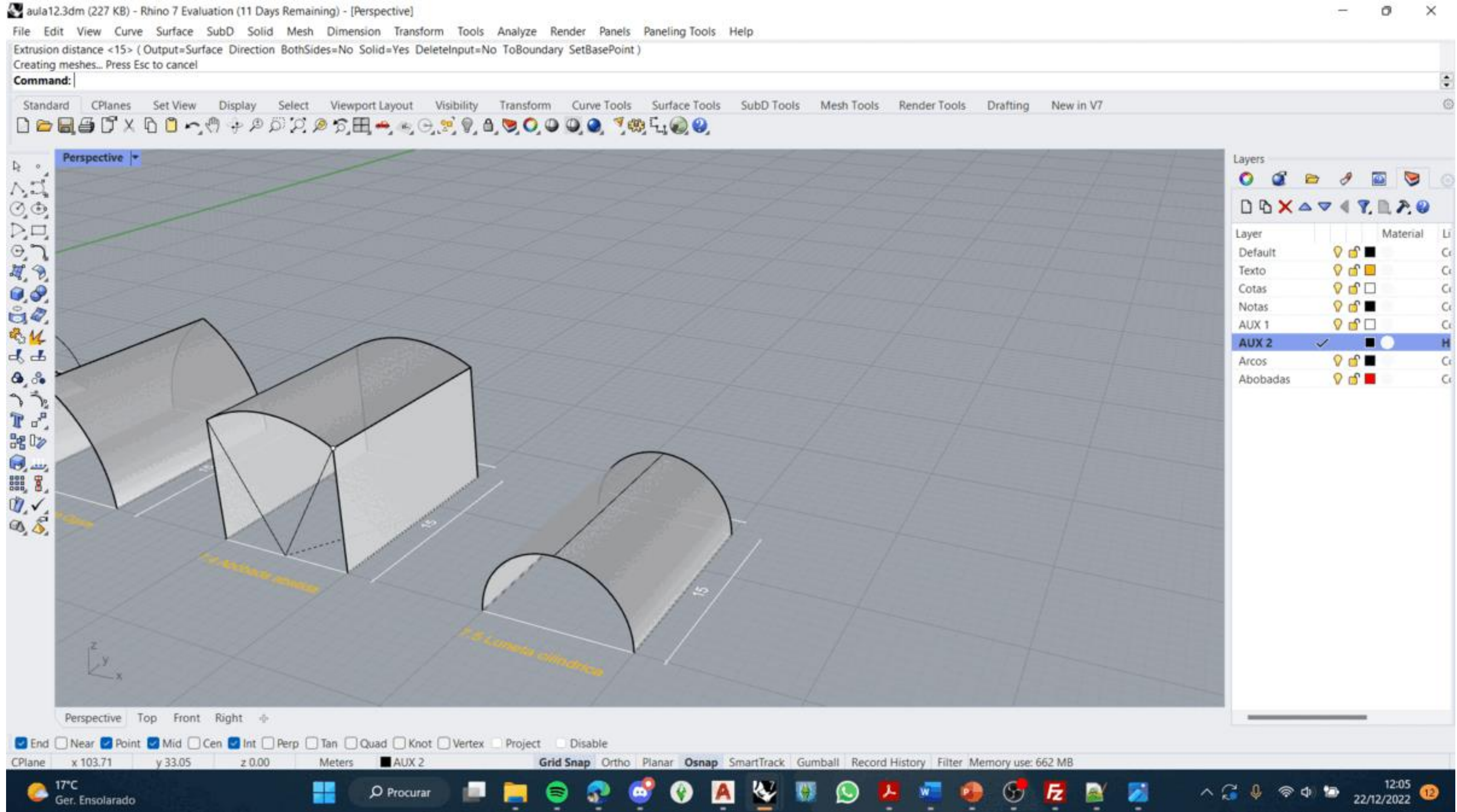

# Exerc. 7.5 – Luneta cilíndrica

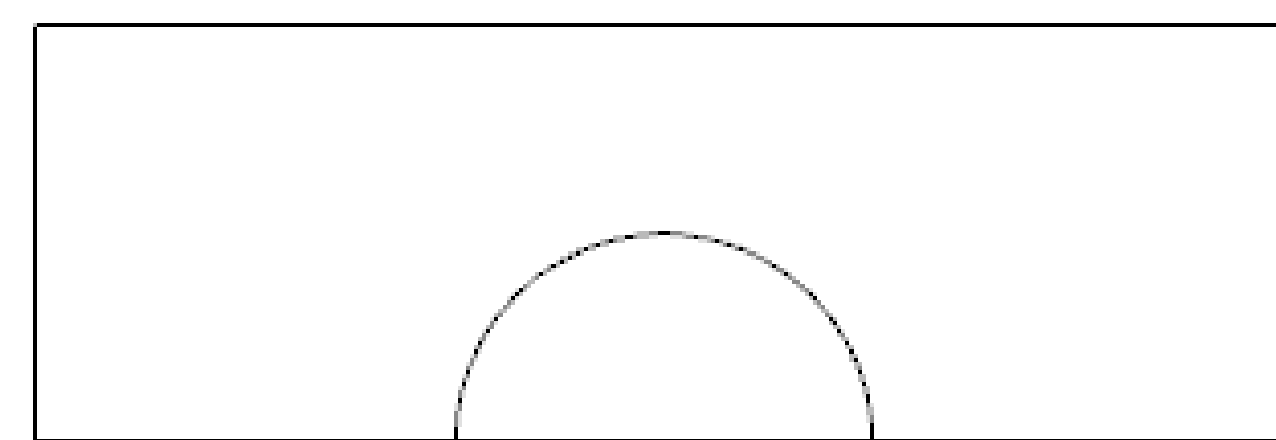
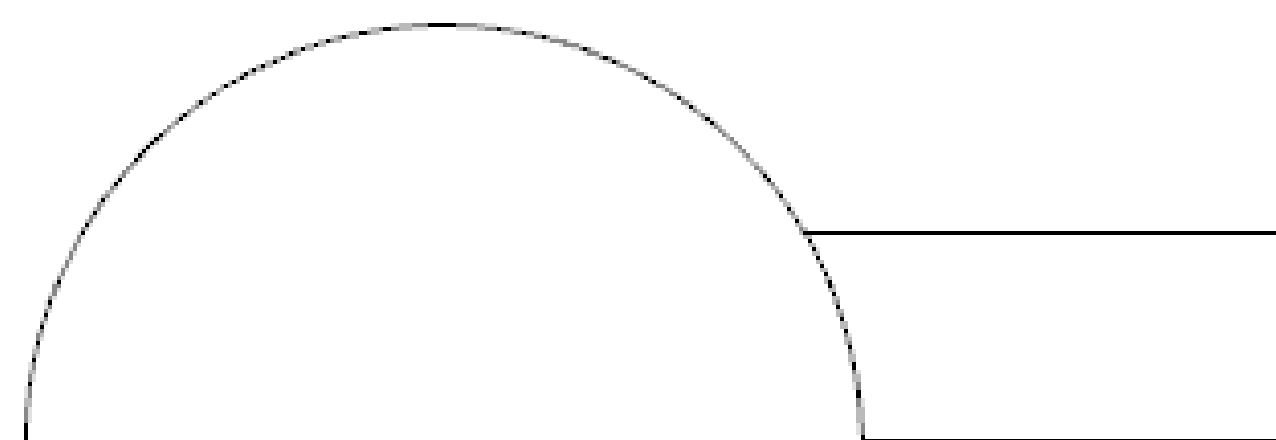
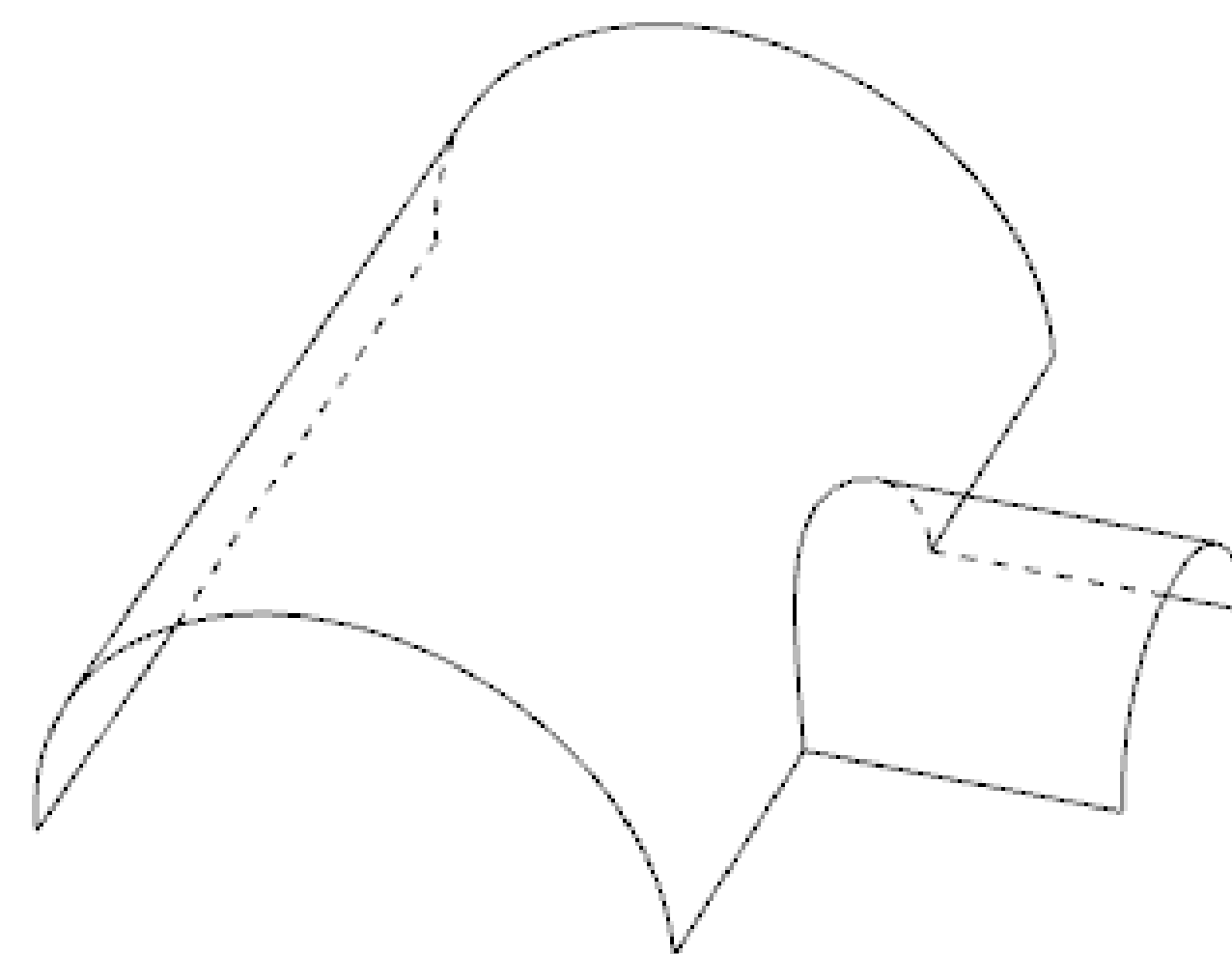
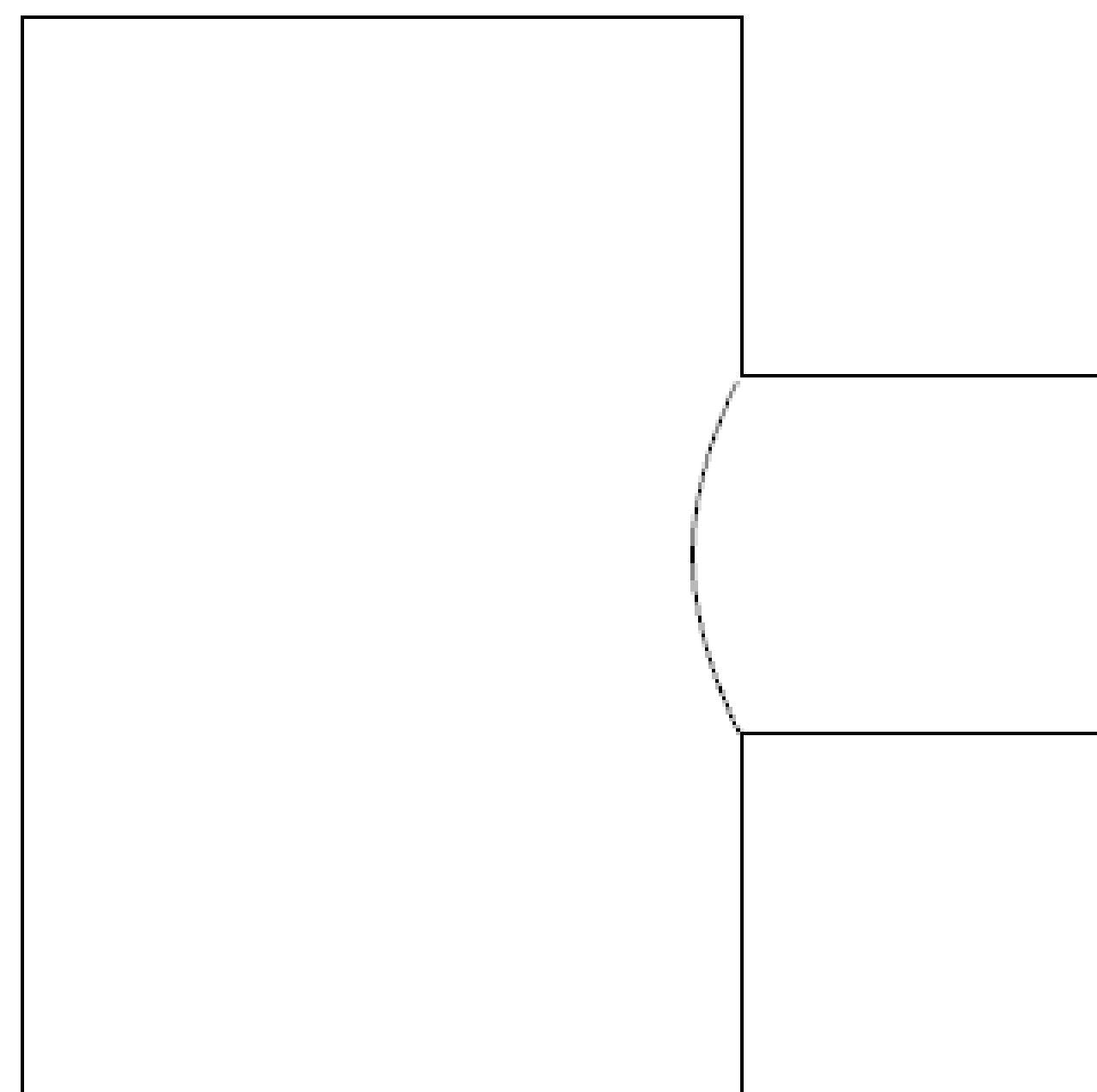

Exerc. 7.5 – Luneta cilíndrica





Exerc. 7.5 – Luneta cilíndrica

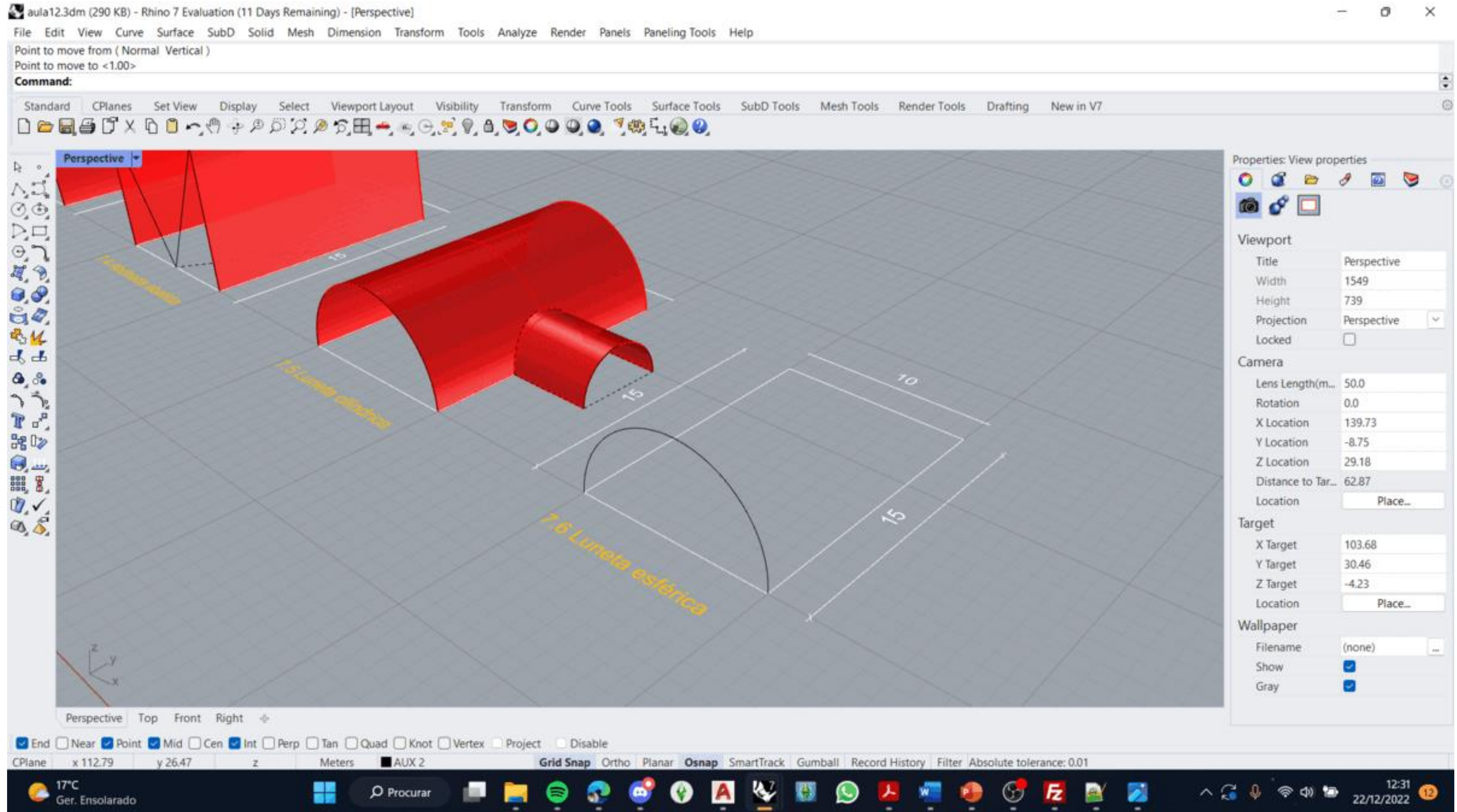

# Exerc. 7.6 – Luneta esférica

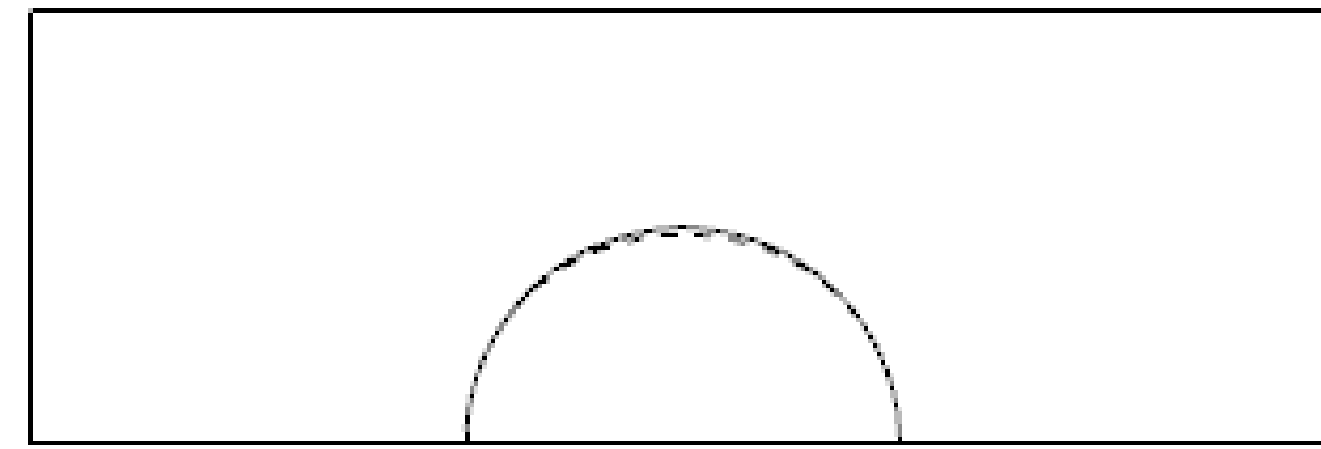
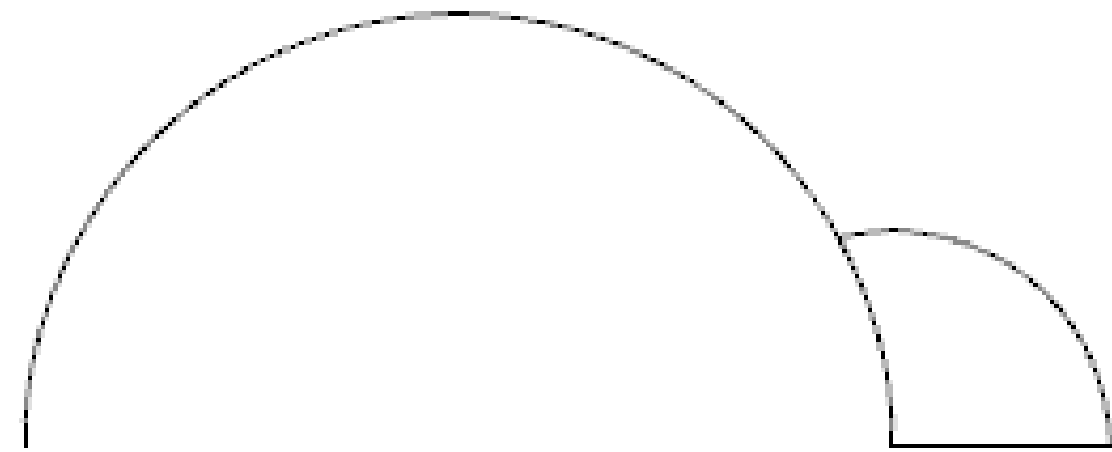
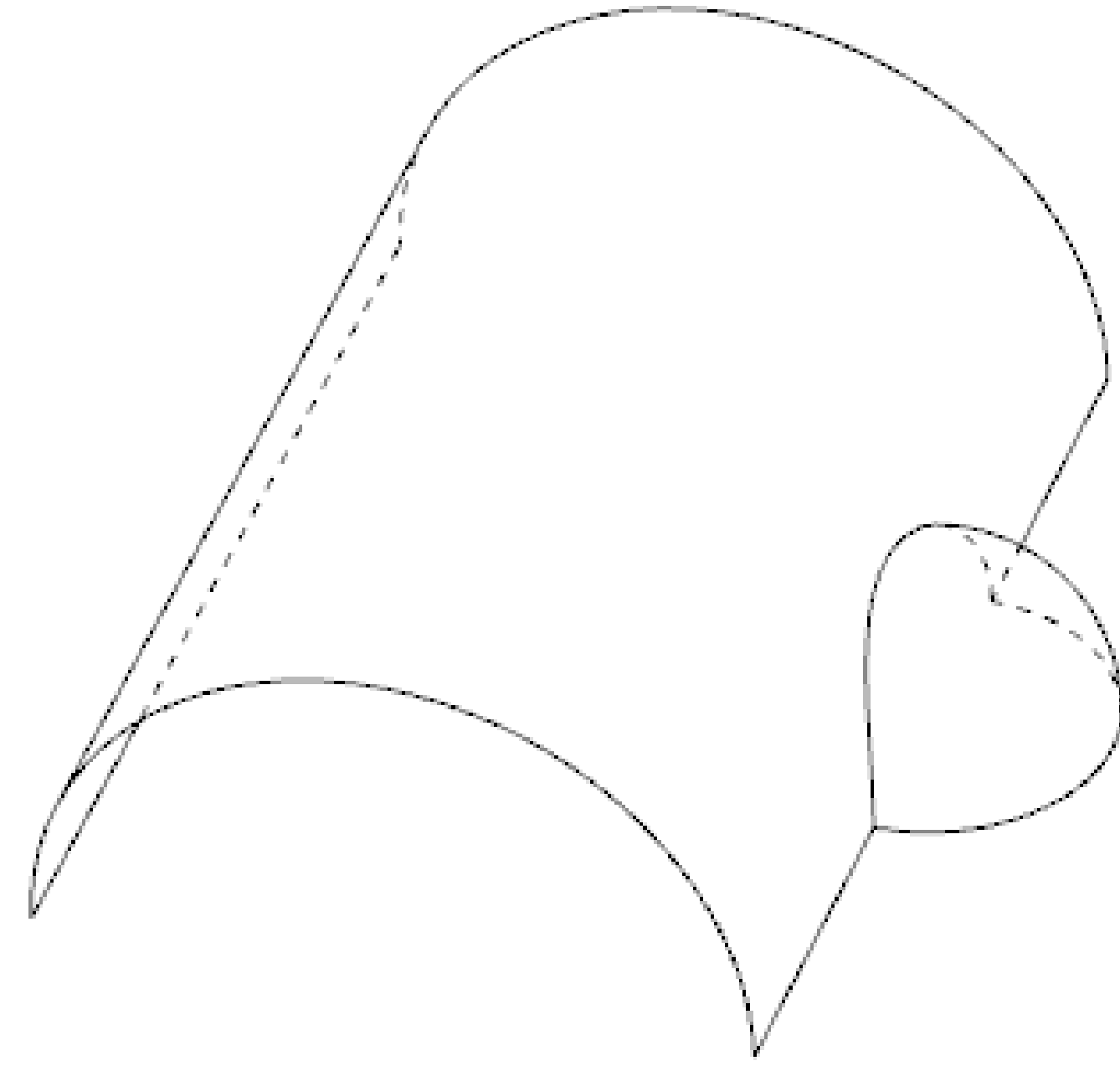
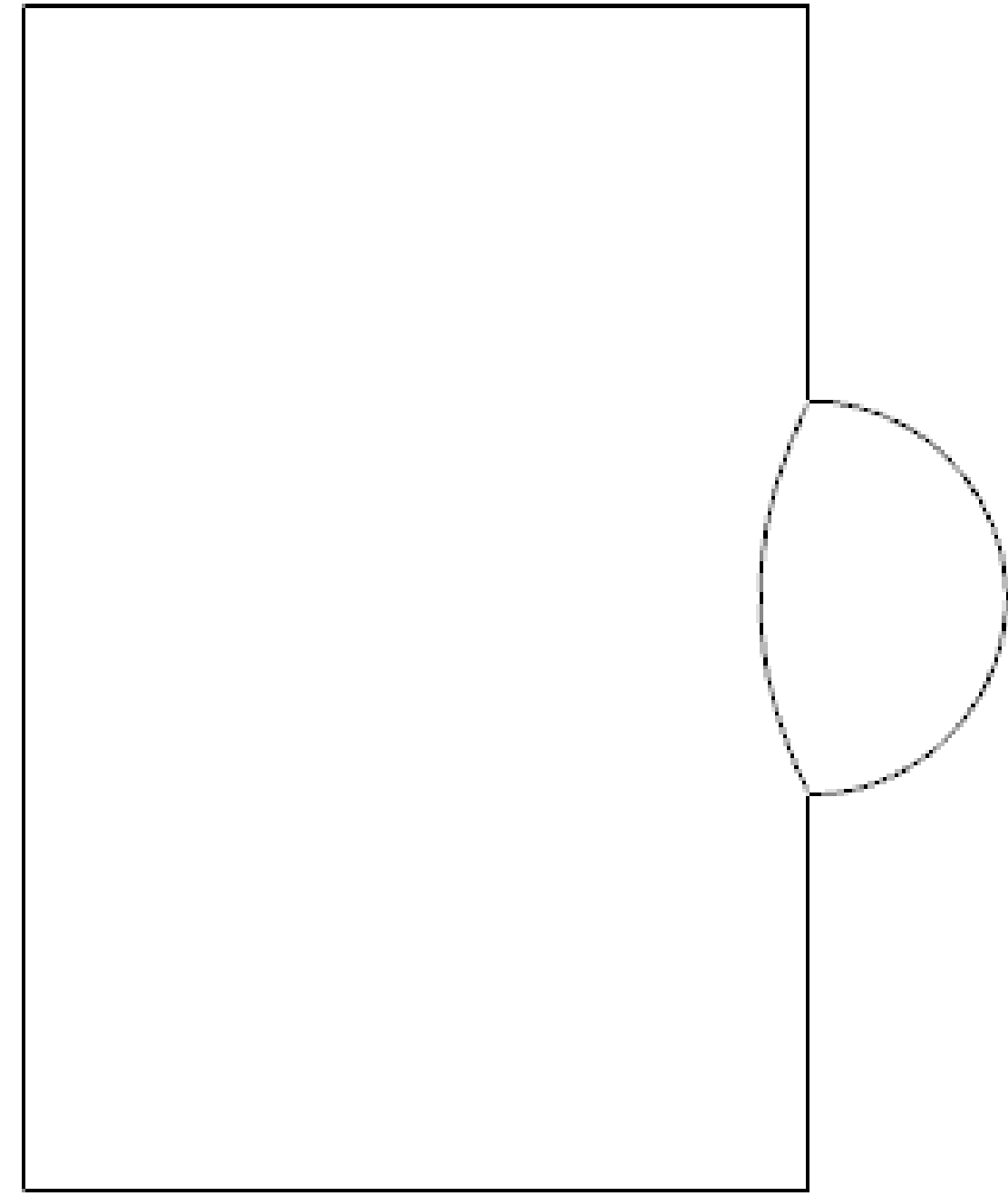

Exerc. 7.6 – Luneta esférica

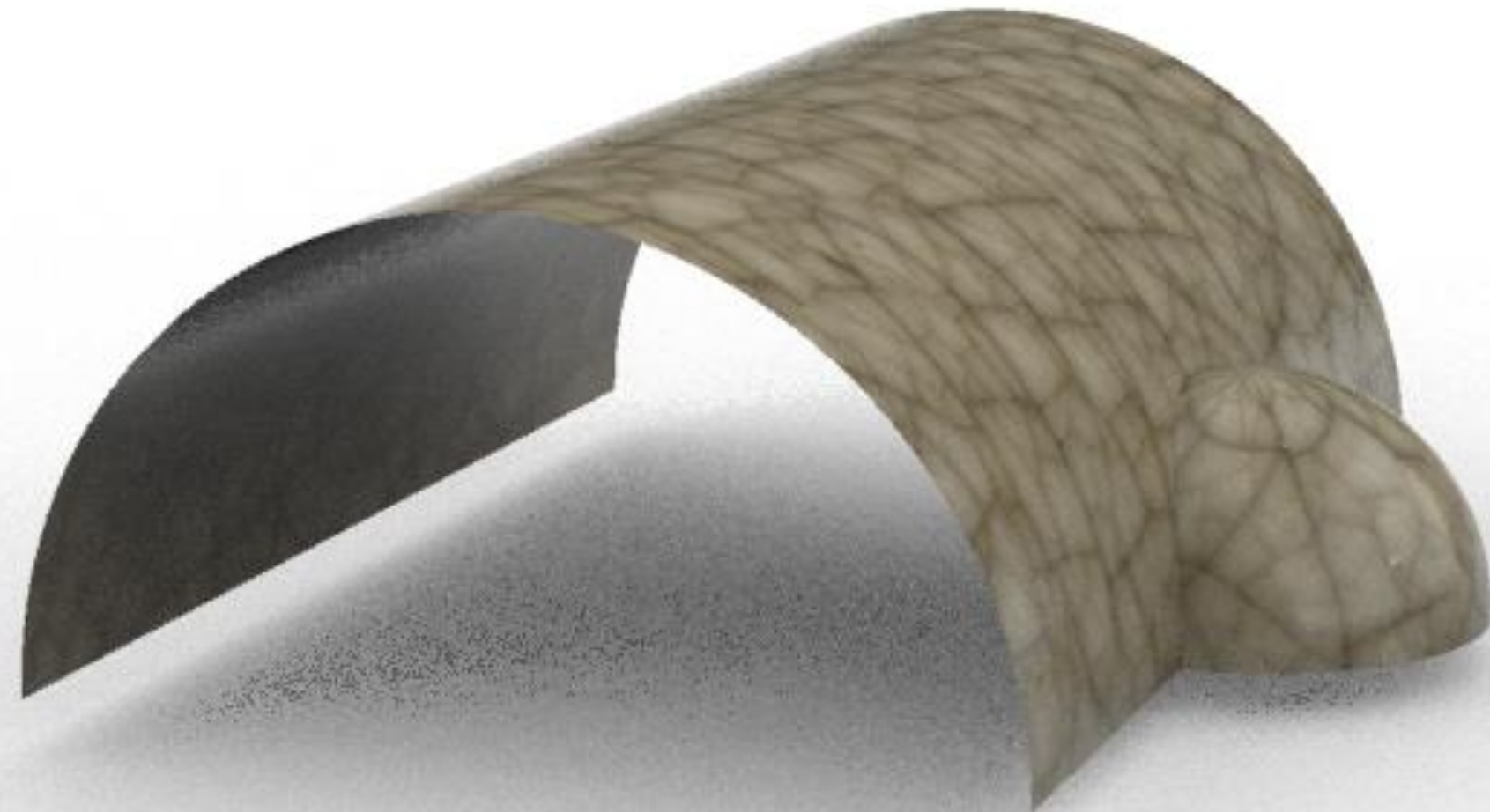

Exerc. 7.6 – Luneta esférica

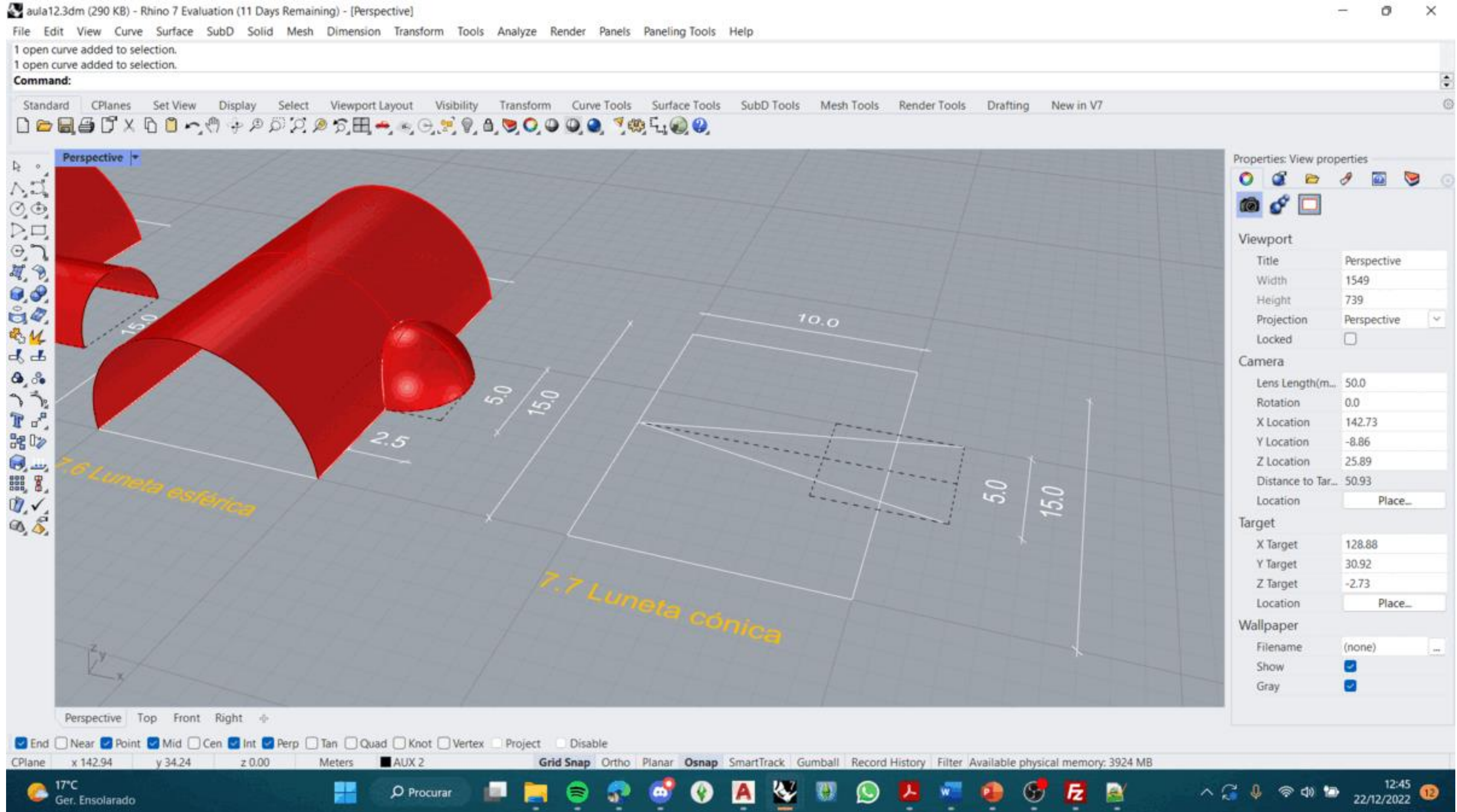

# Exerc. 7.7 – Luneta cónica

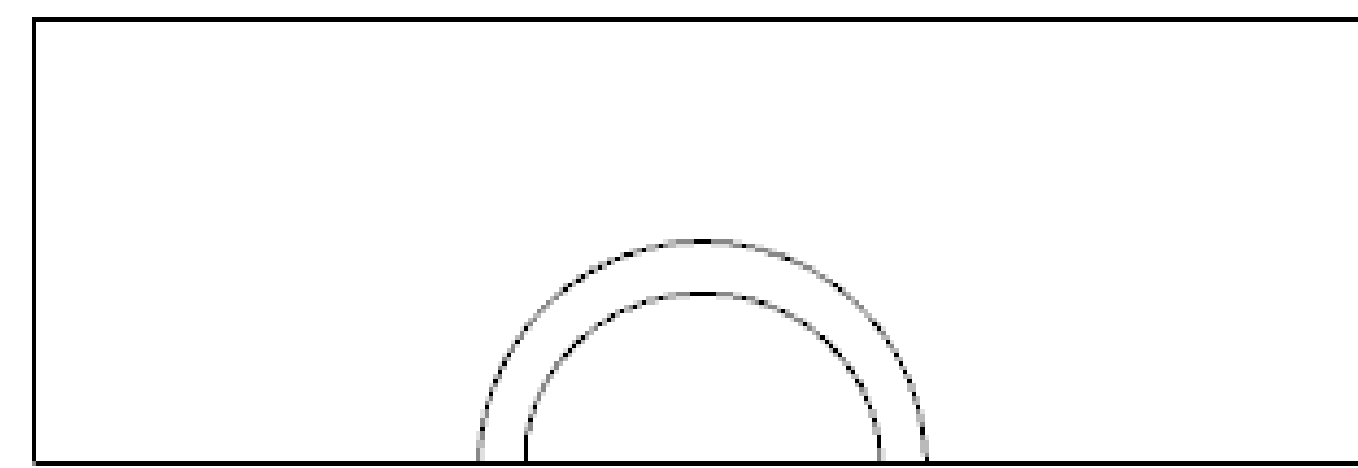
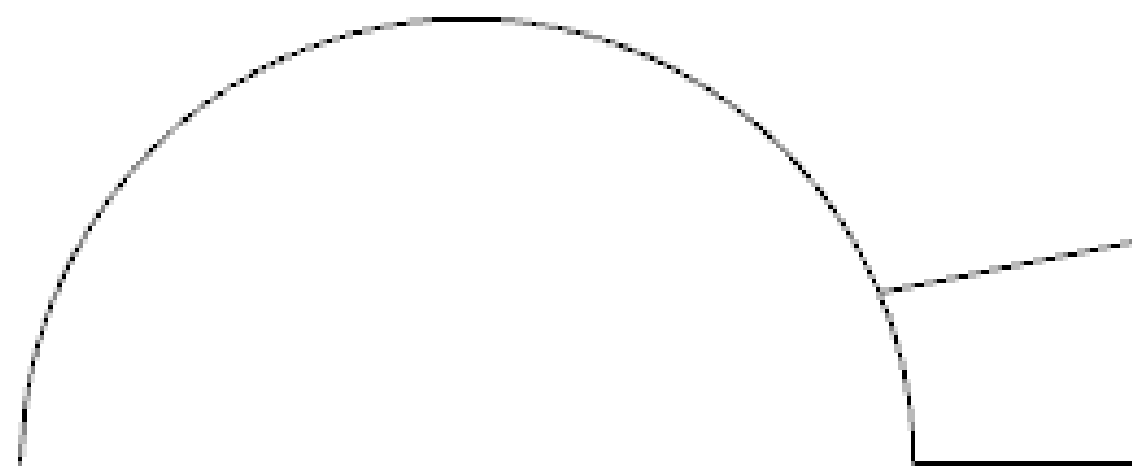
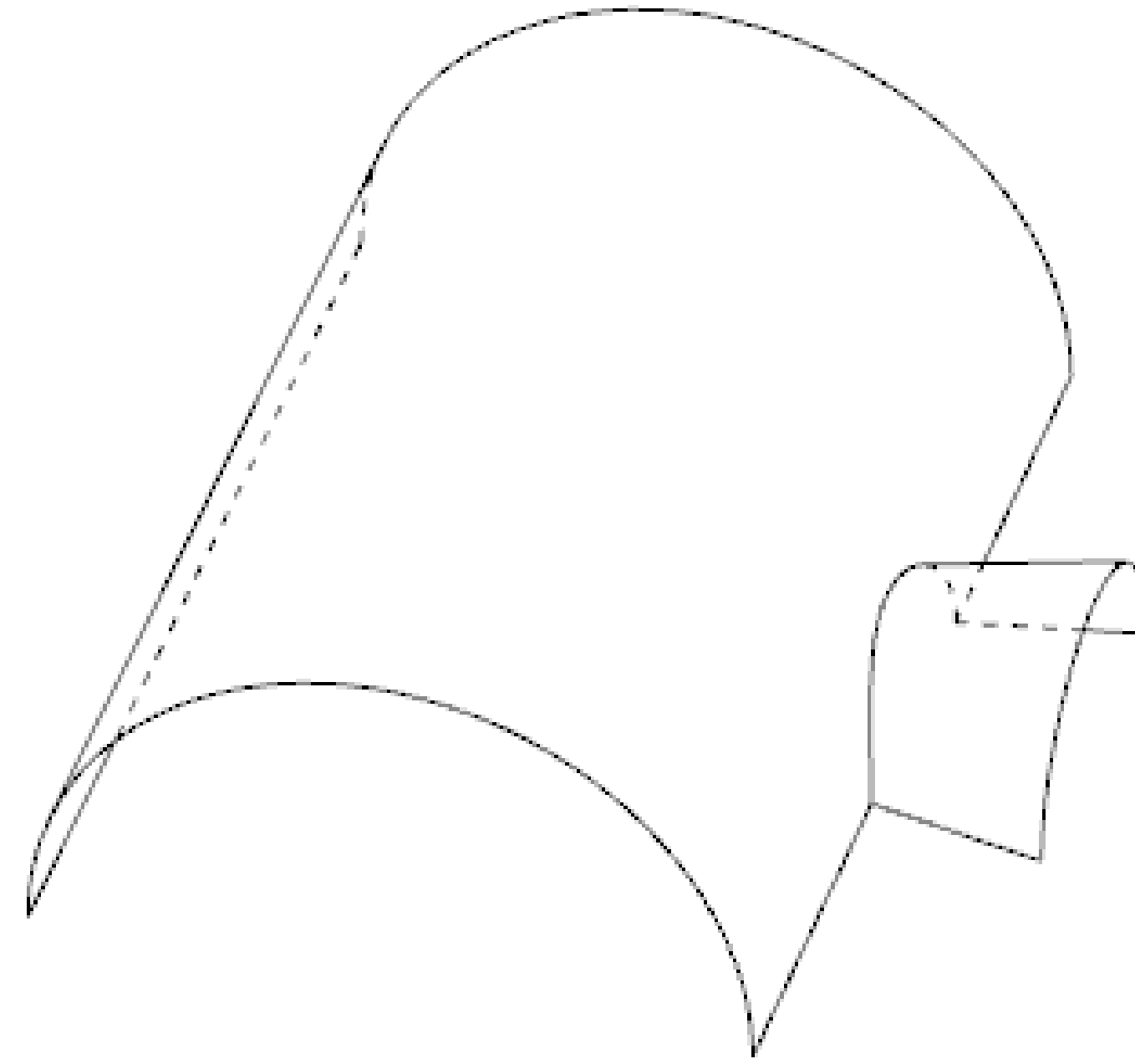
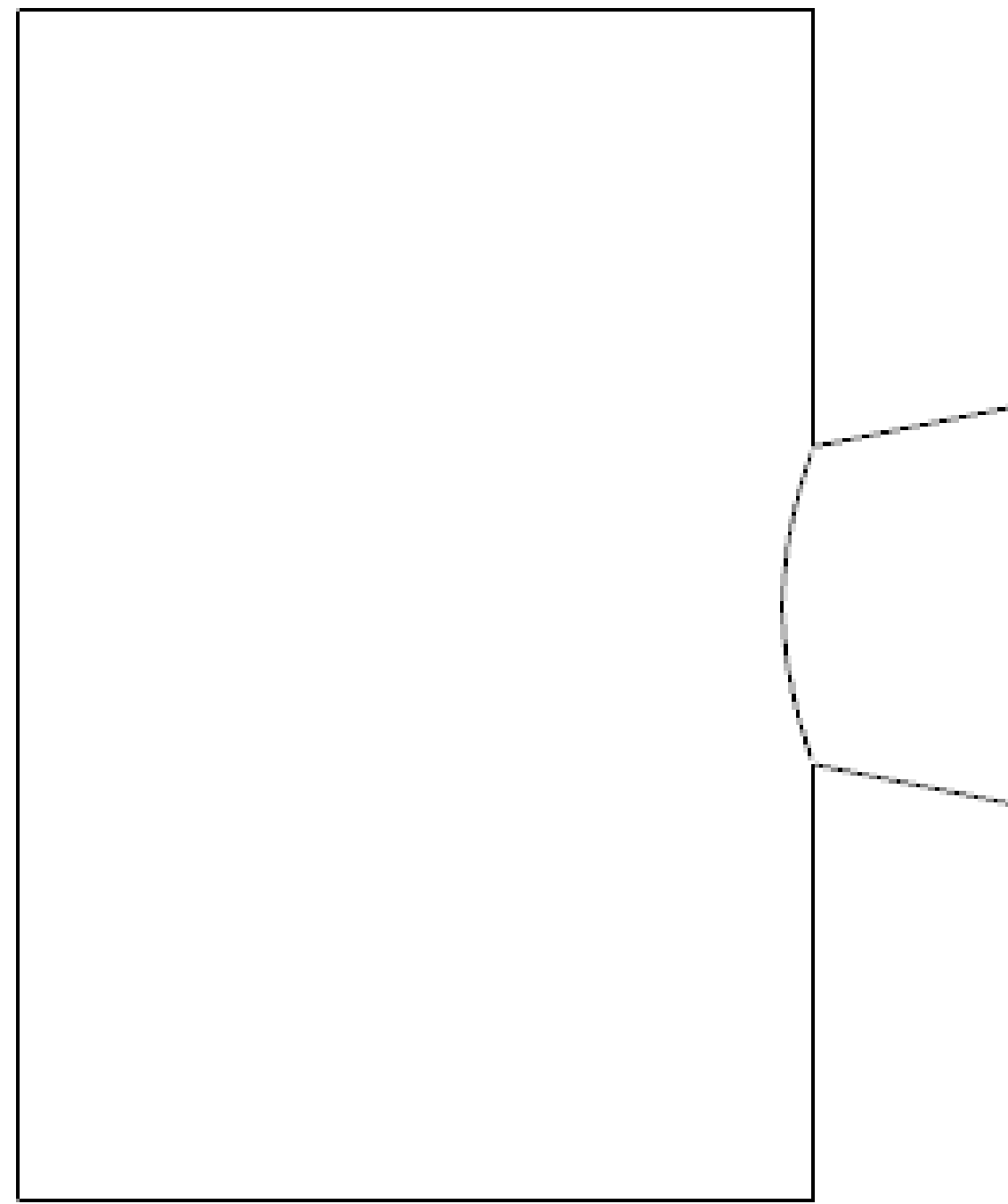

Exerc. 7.7 – Luneta cónica

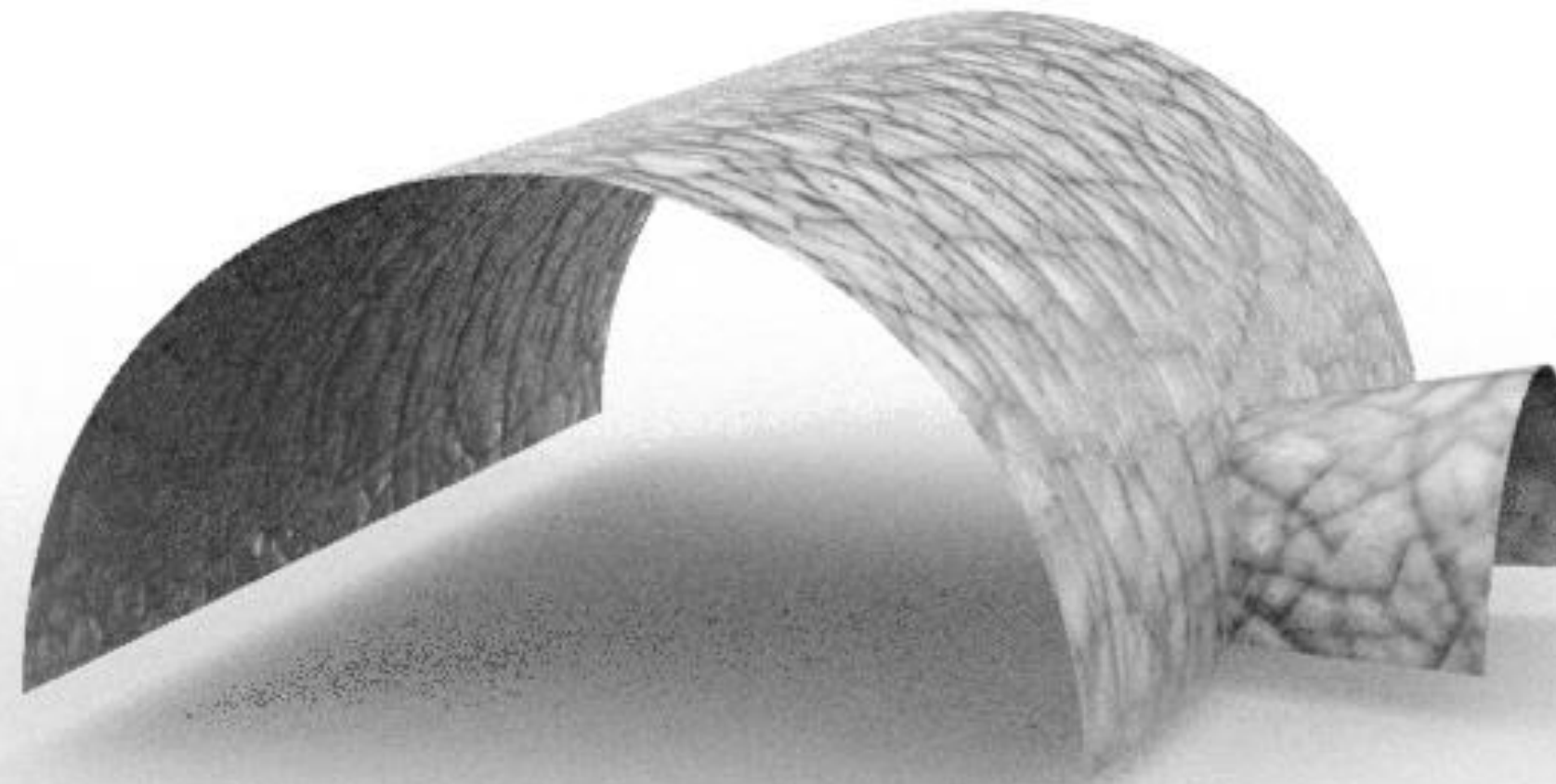

Exerc. 7.7 – Luneta cónica

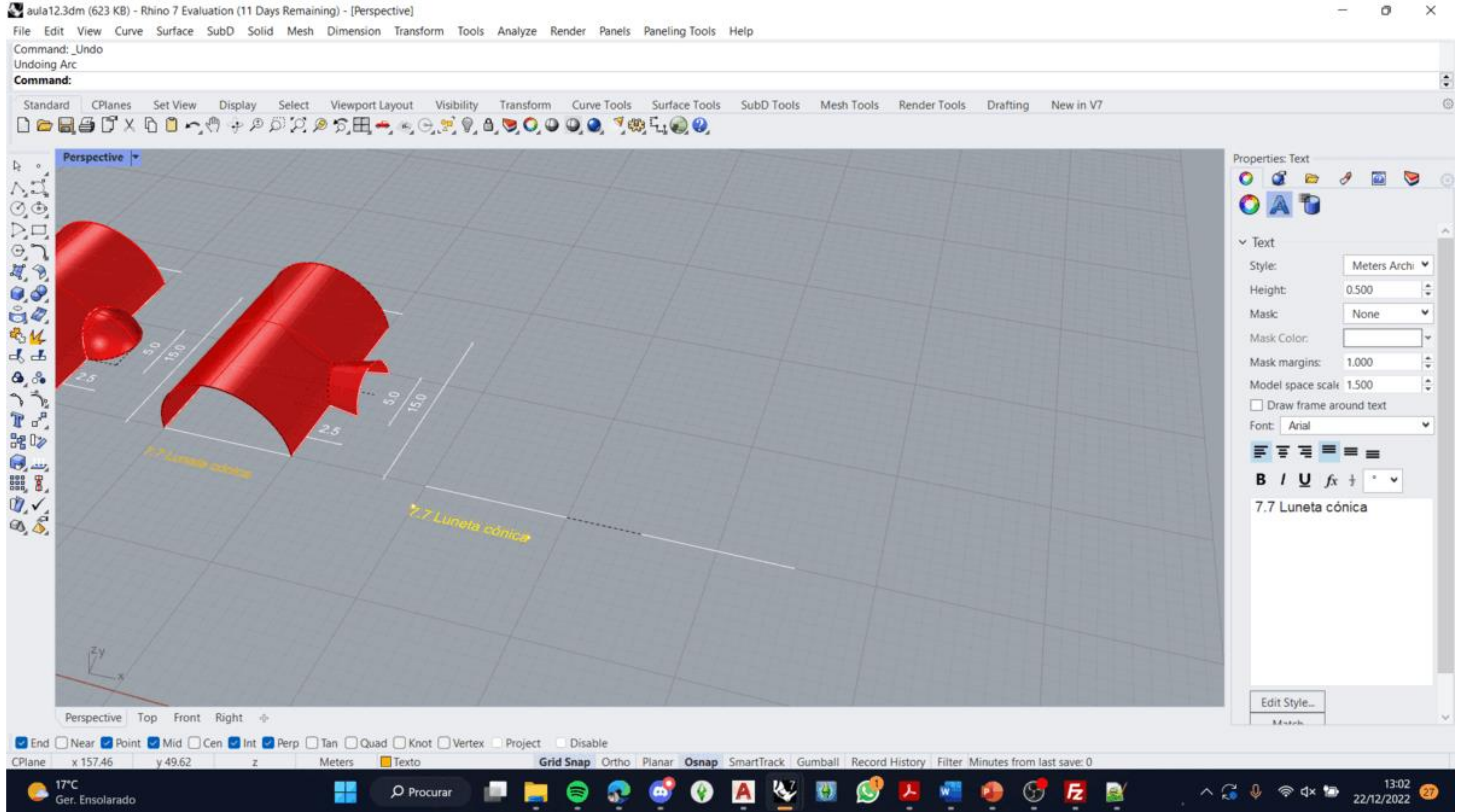

# Exerc. 7.8 – Abóbada tural



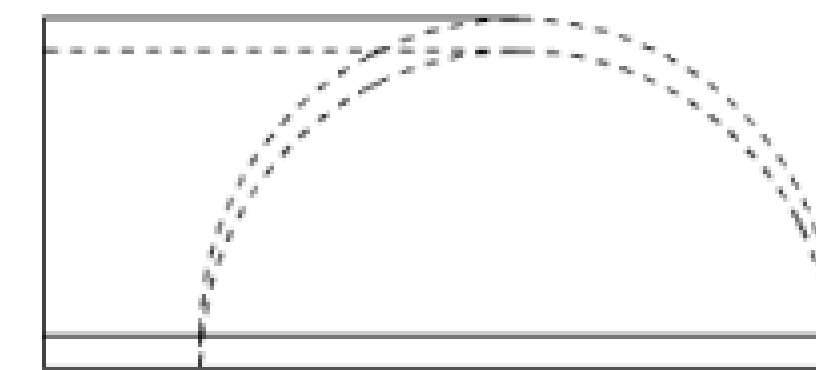
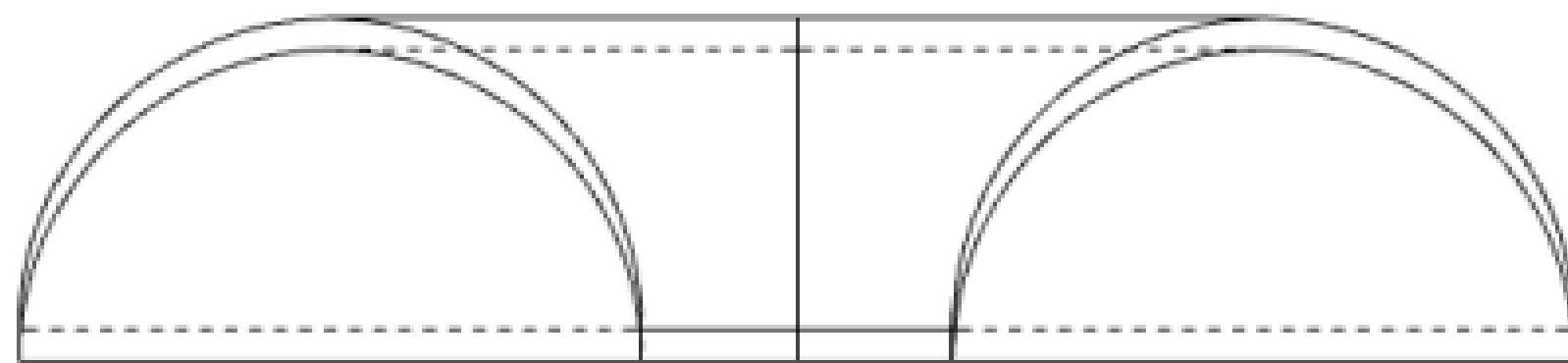
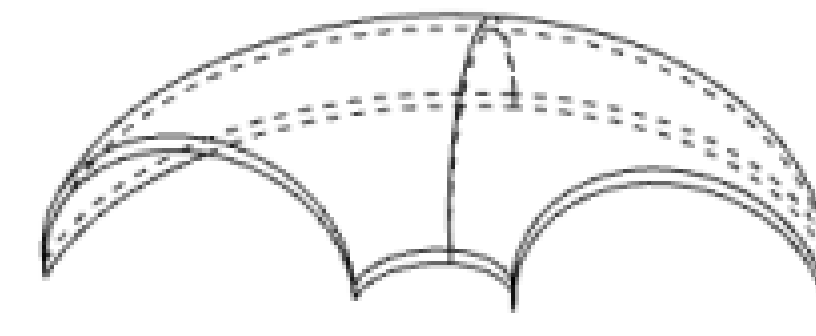
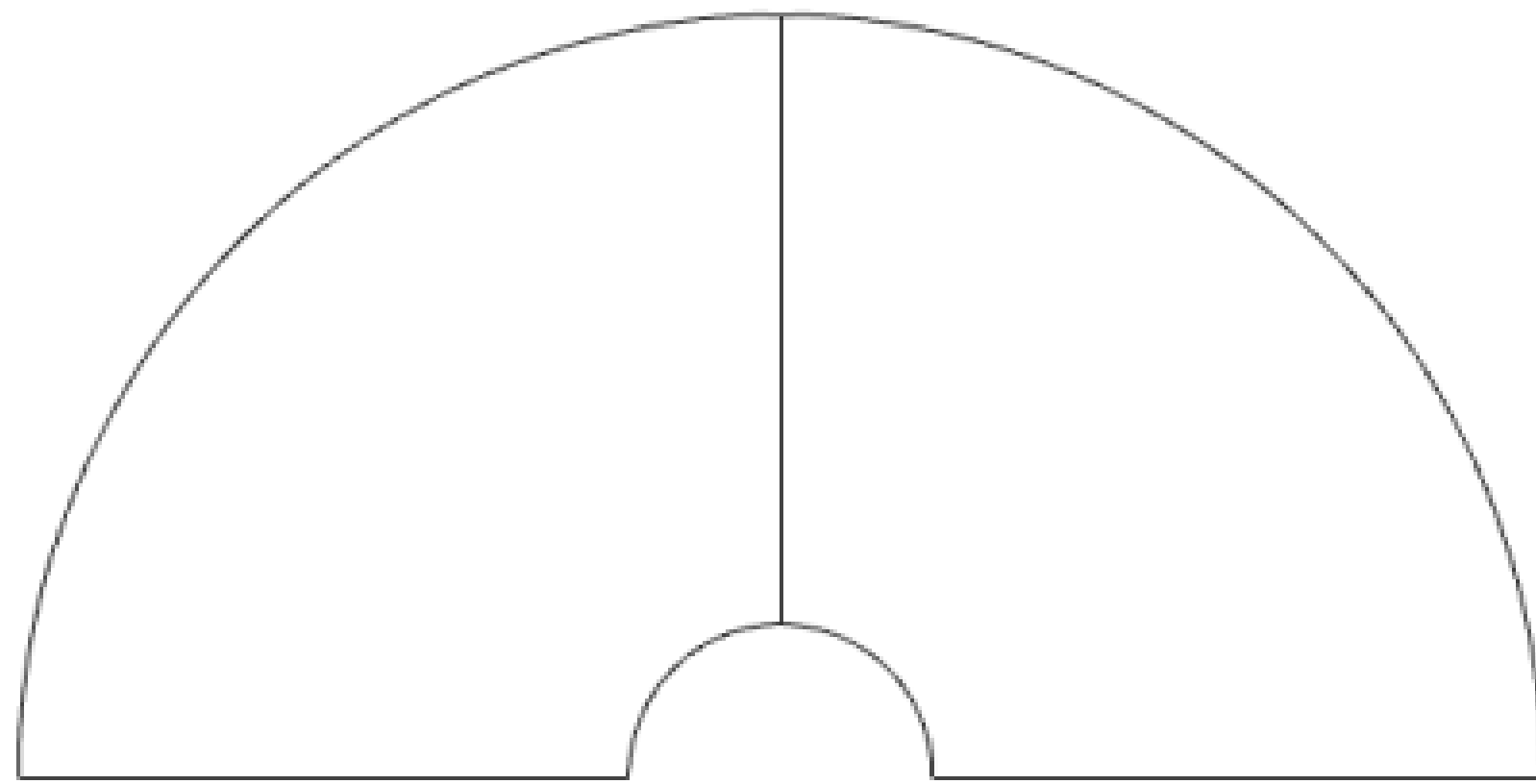

Exerc. 7.8 – Abóbada tural

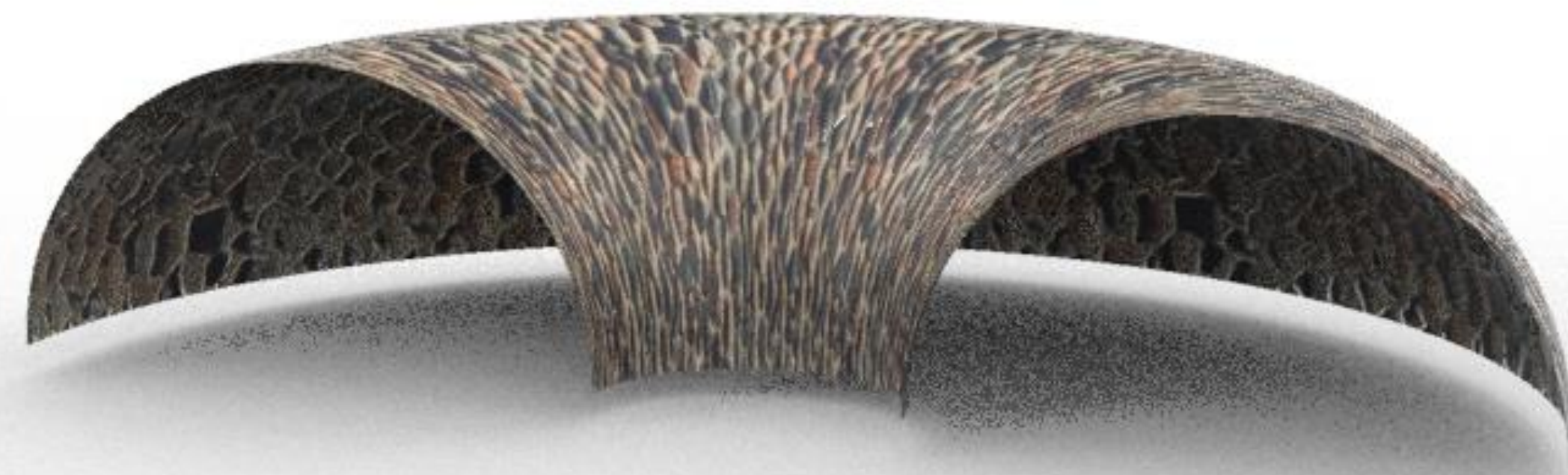

Exerc. 7.8 – Abóbada tural

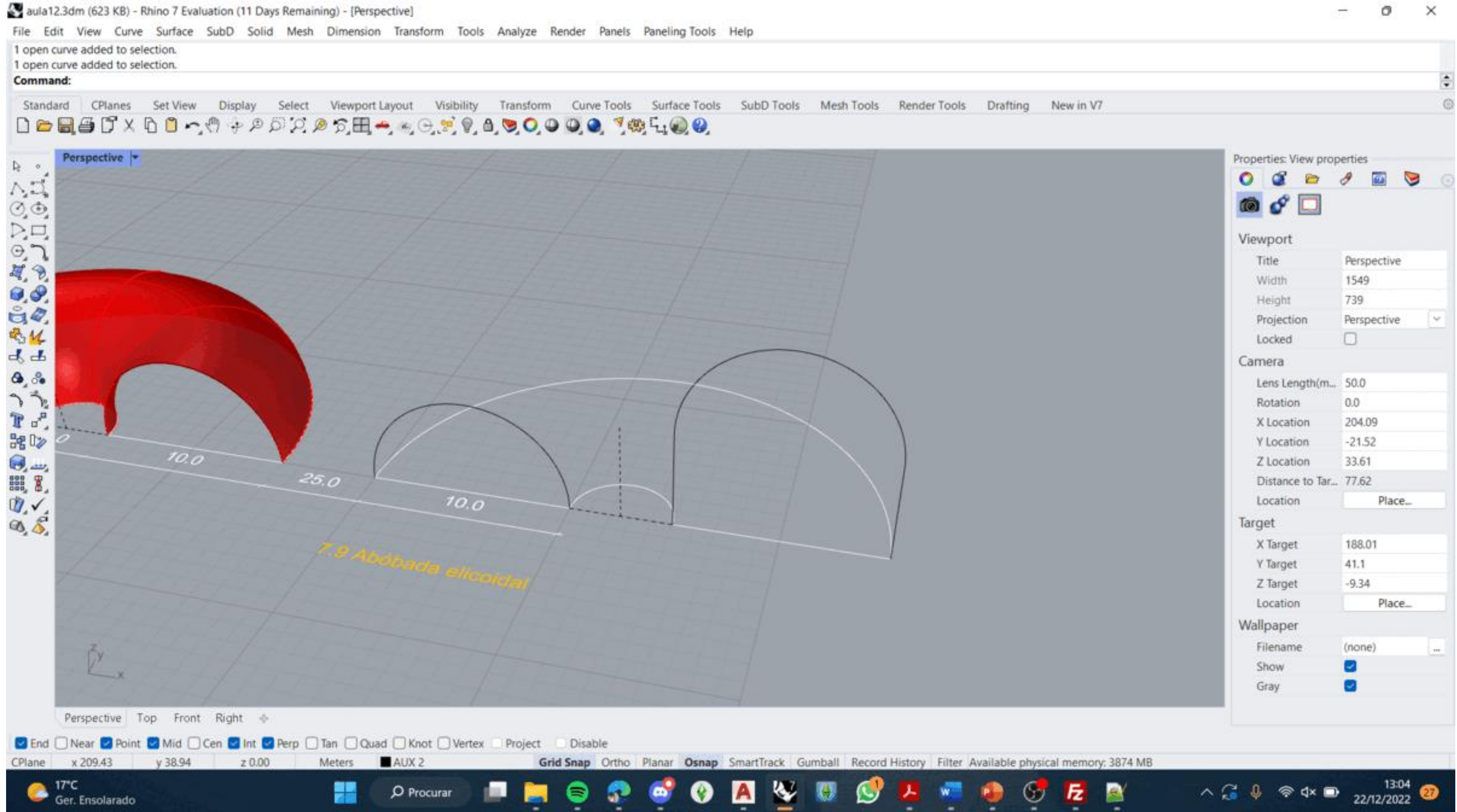

# Exerc. 7.9 – Abóbada helicoidal

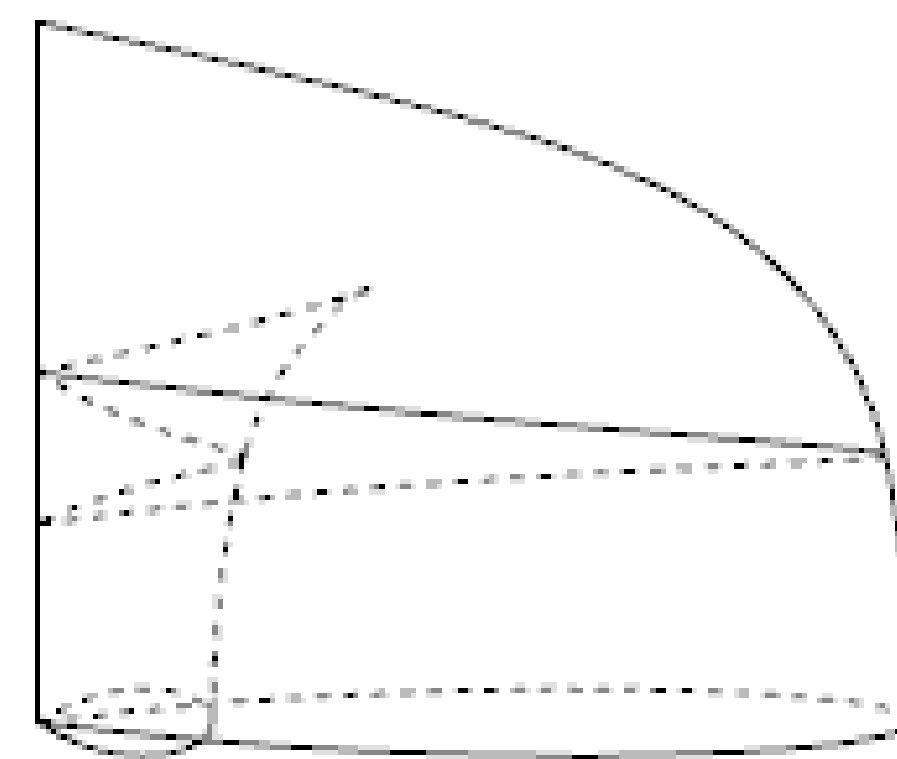
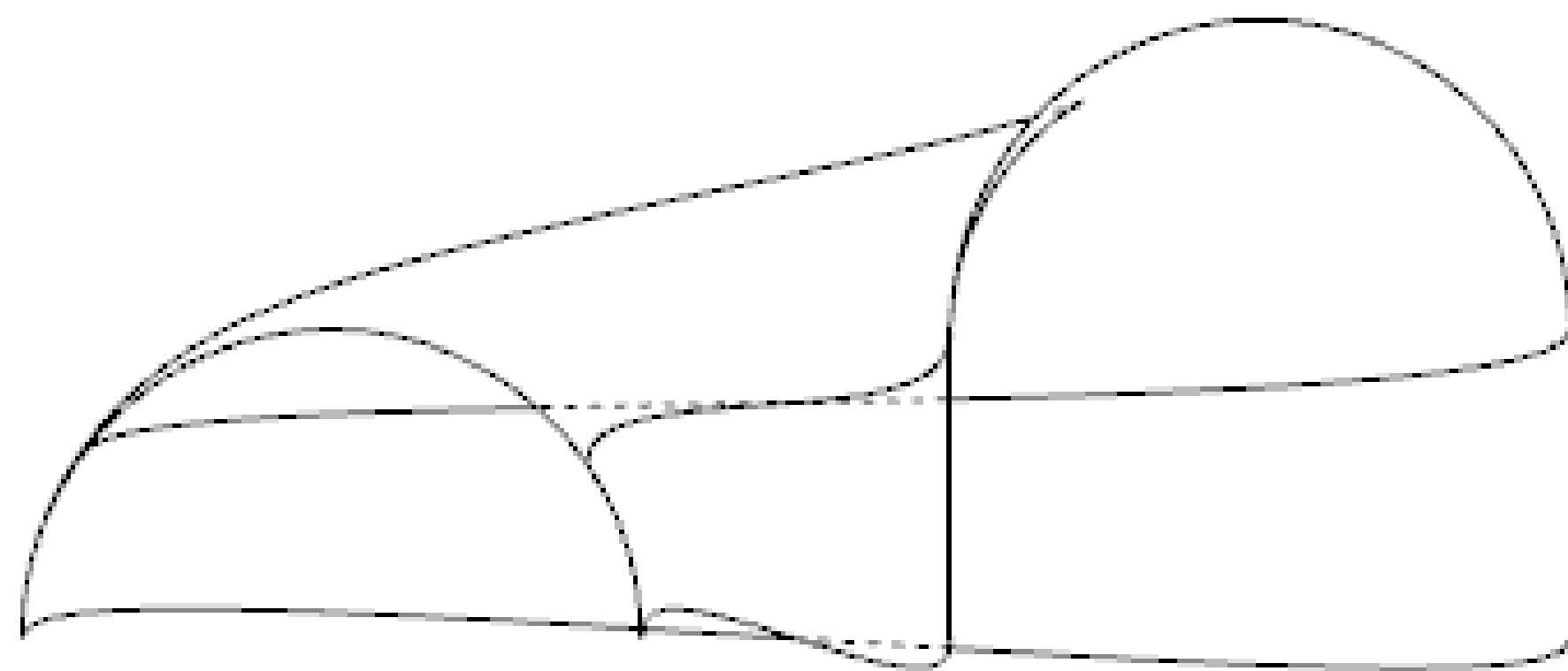
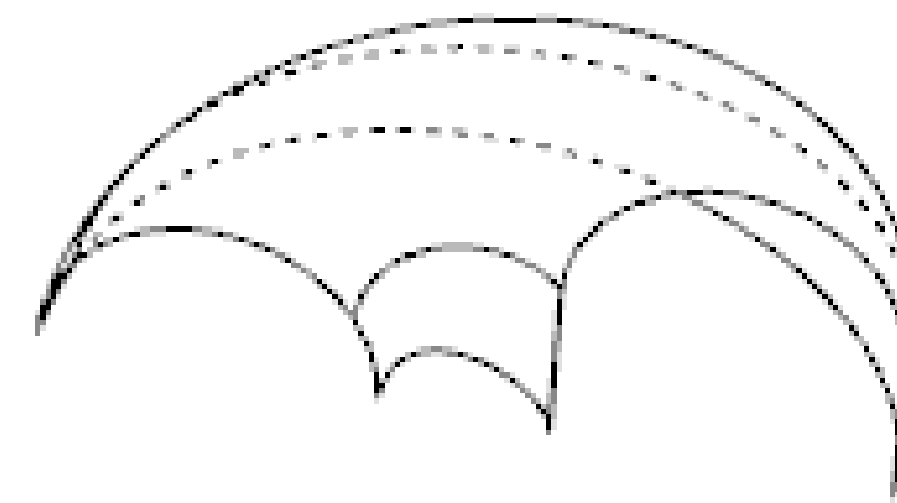
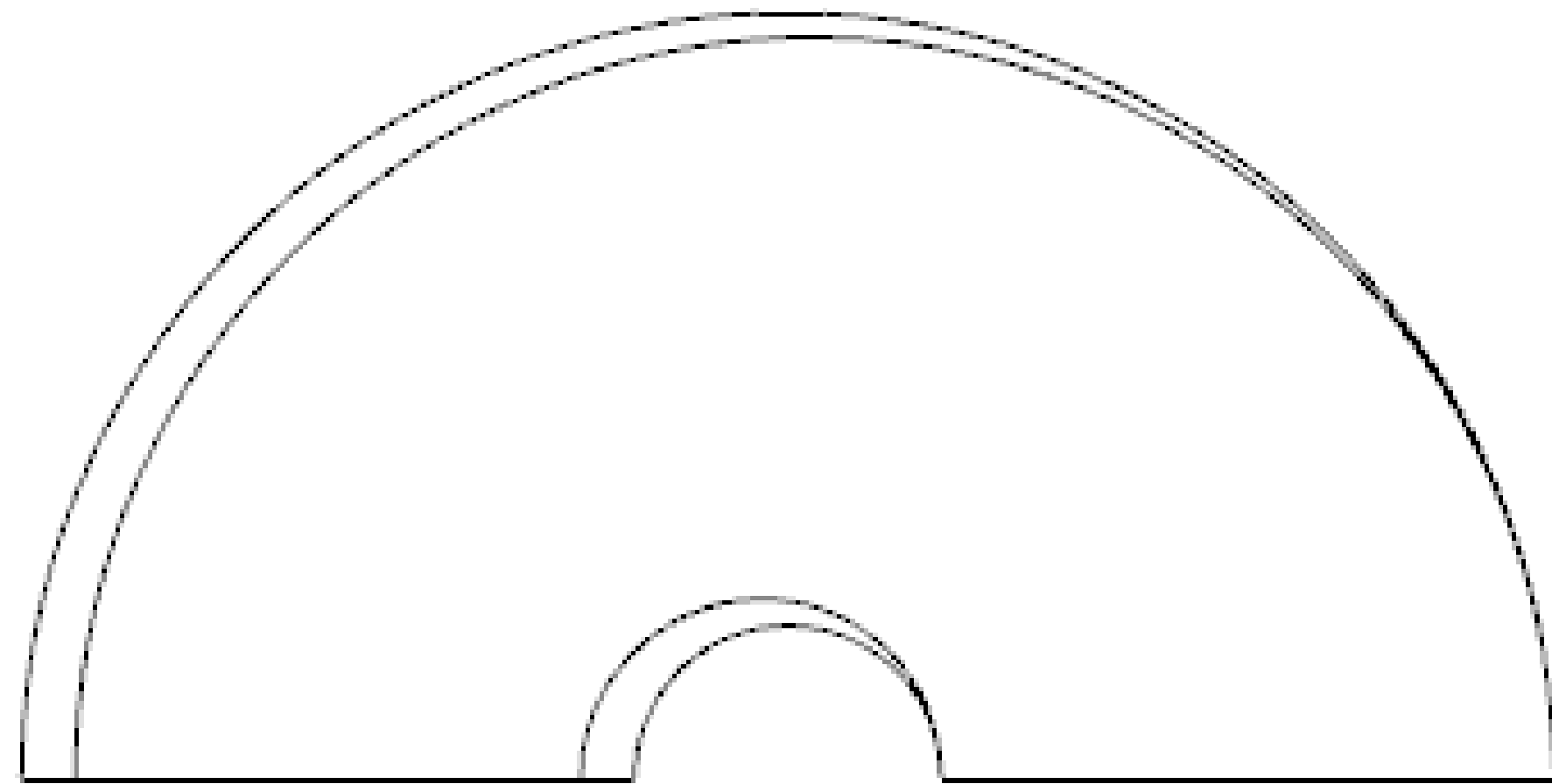

Exerc. 7.9 – Abóbada helicoidal



Exerc. 7.9 – Abóbada helicoidal



# 8- Exercícios Grasshopper

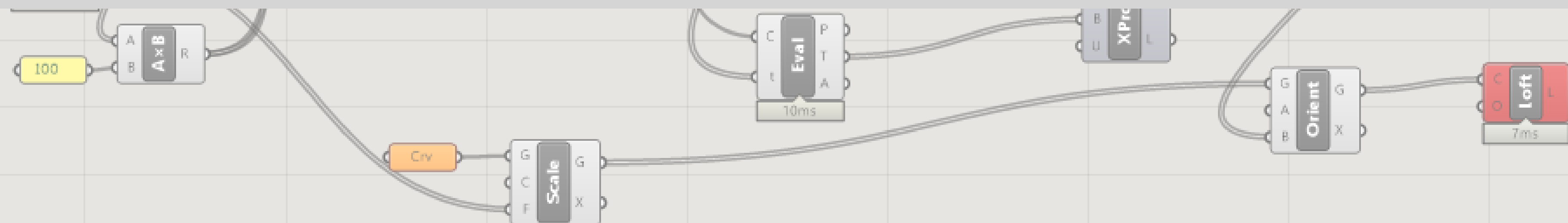

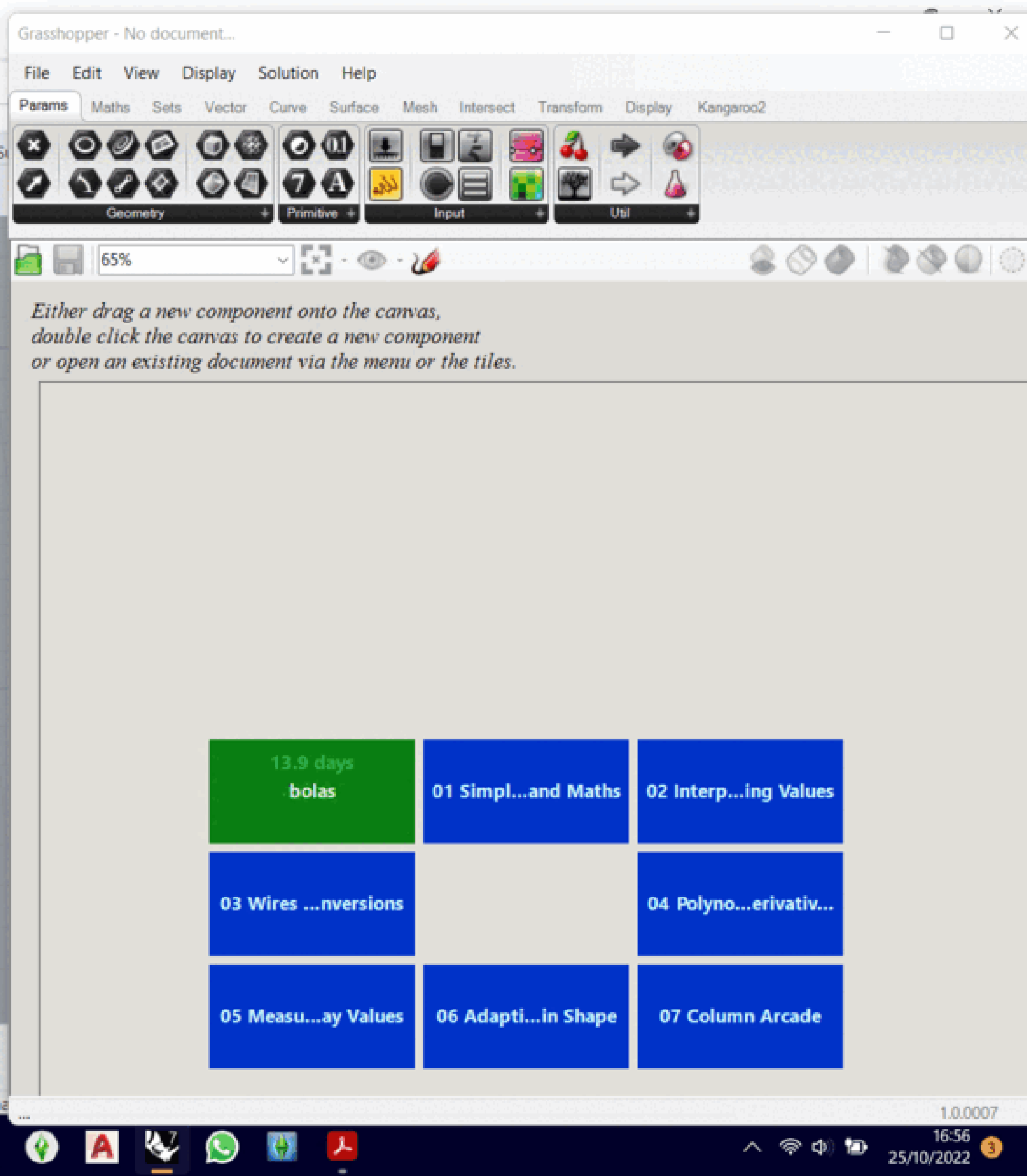
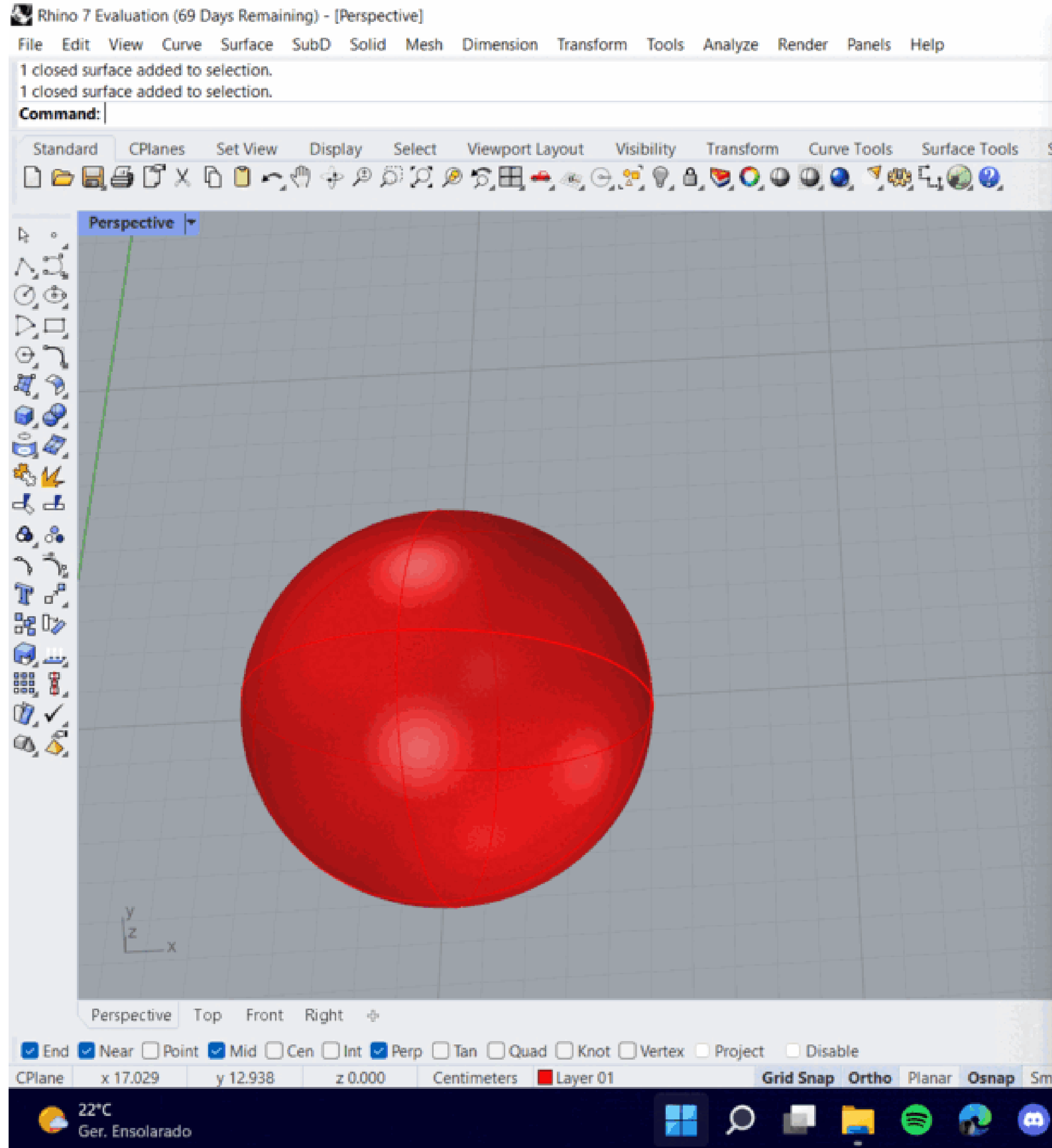

# Exerc. 8.1 - Grasshopper

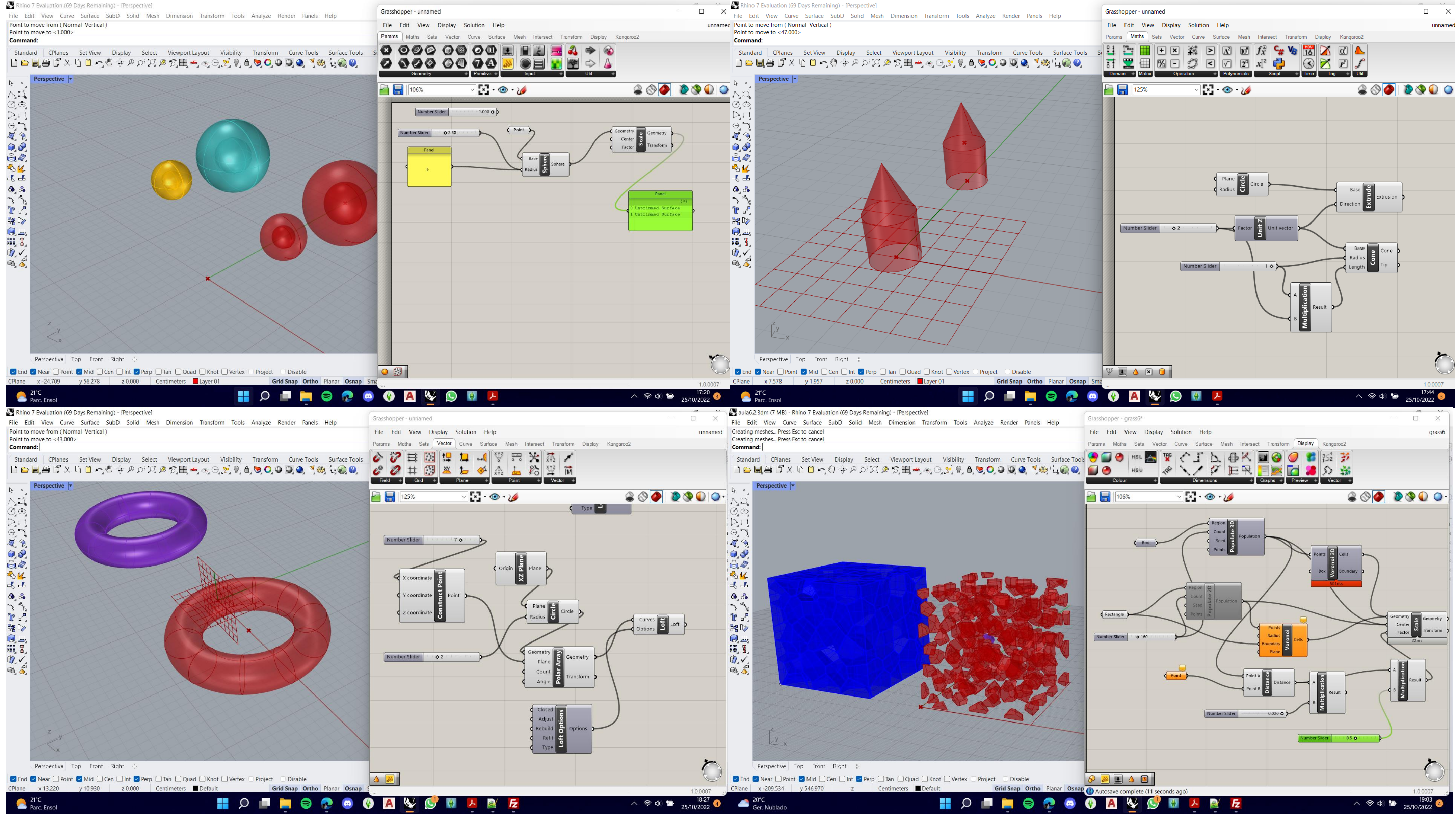

# Exerc. 8.1 - Grasshopper



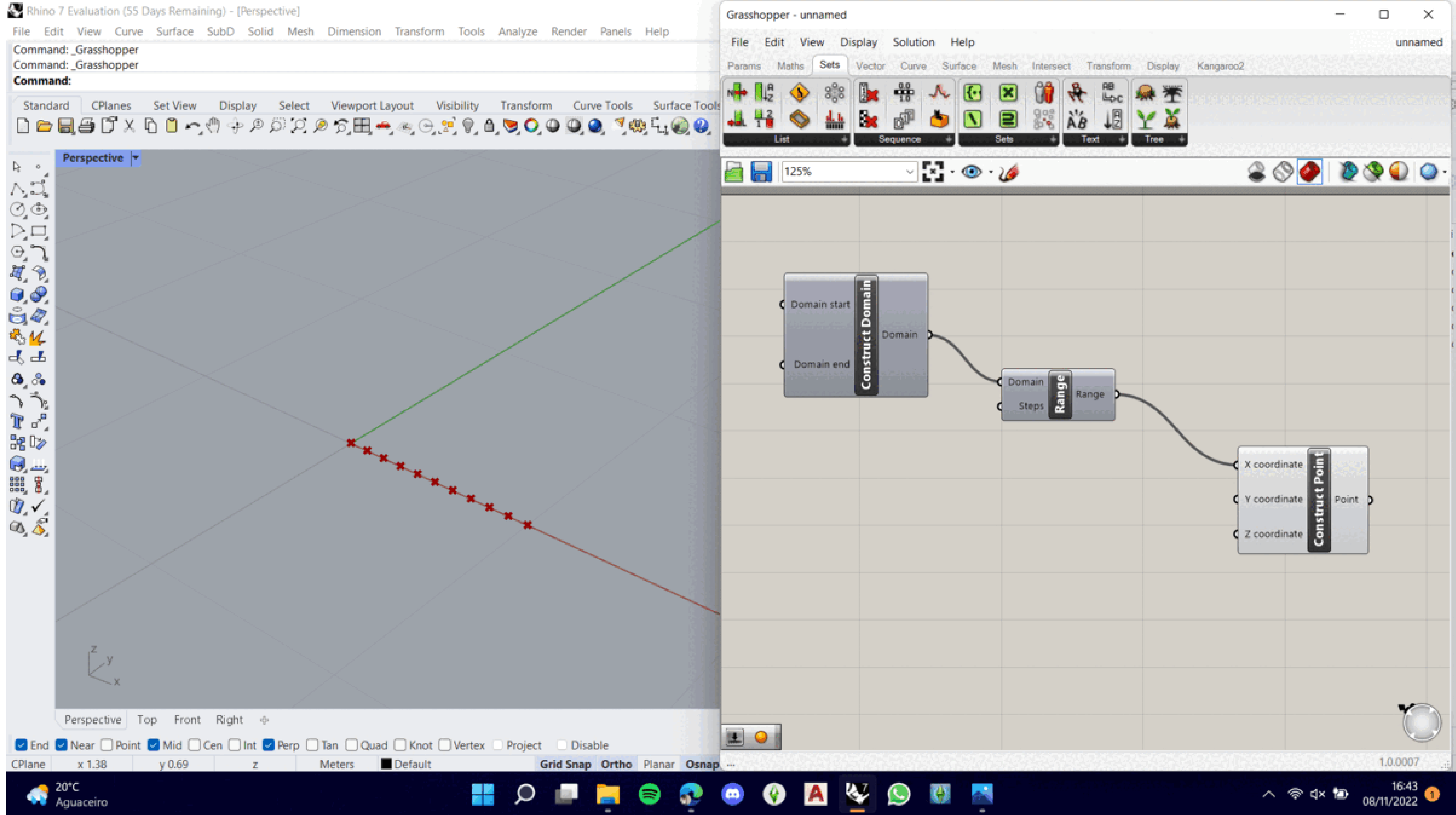

# Exerc.8.2 - Grasshopper

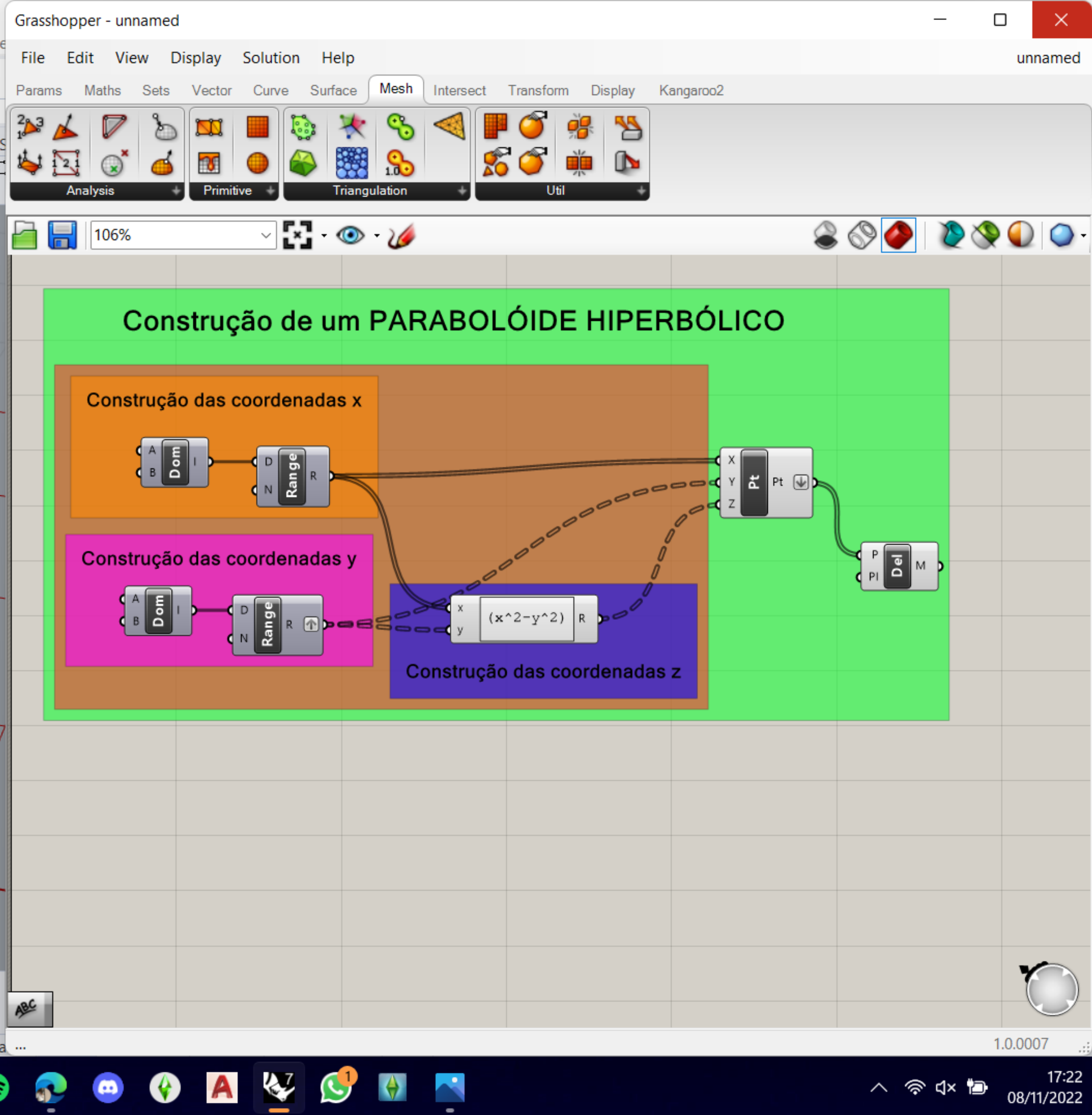
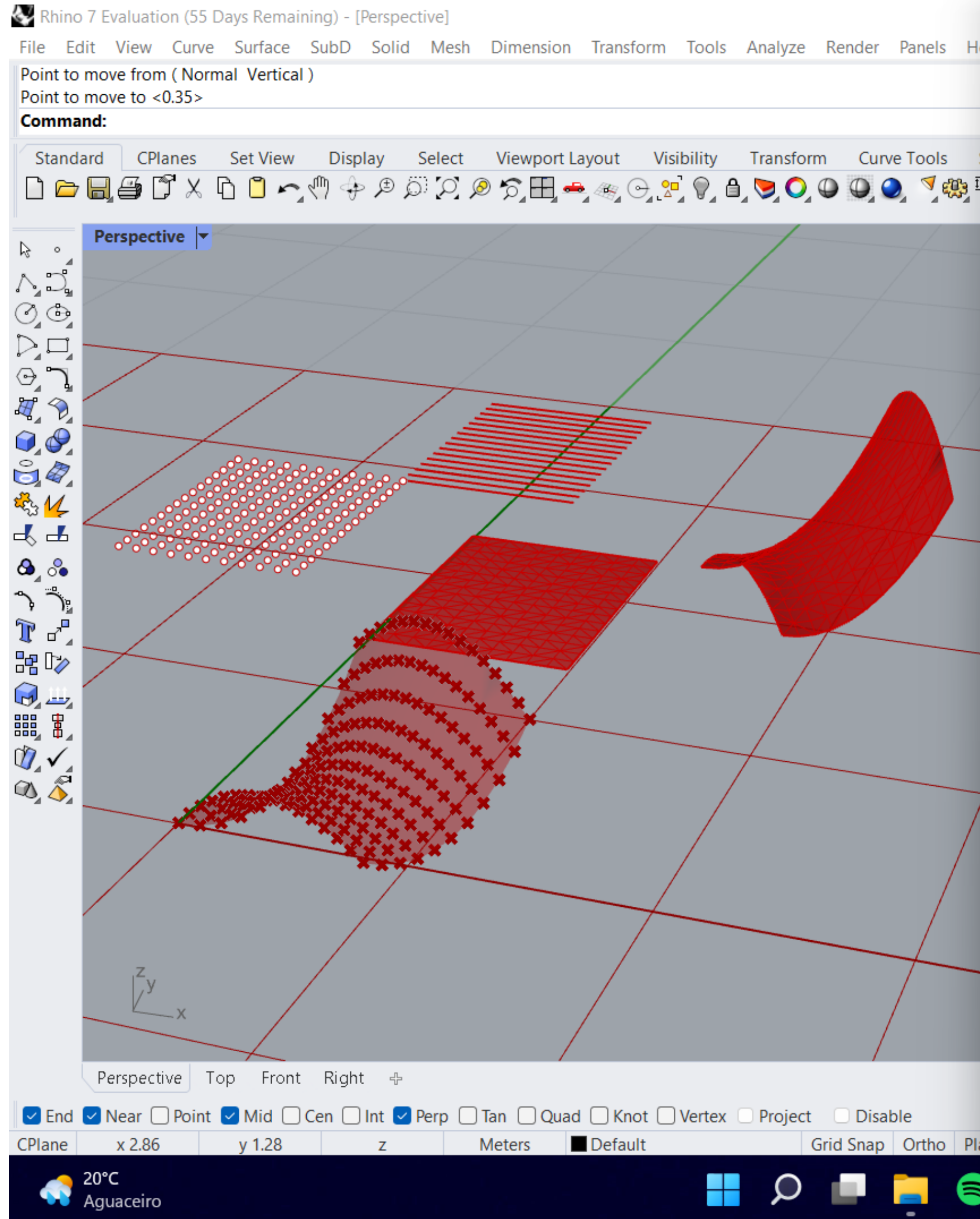

# Exerc. 8.2 - Grasshopper